

SH  
207  
TR 4  
# 11  
c. 2

# Small-scale fisheries of San Miguel Bay, Philippines: options for management and research

Ian R. Smith, Daniel Pauly and  
Antonio N. Mines

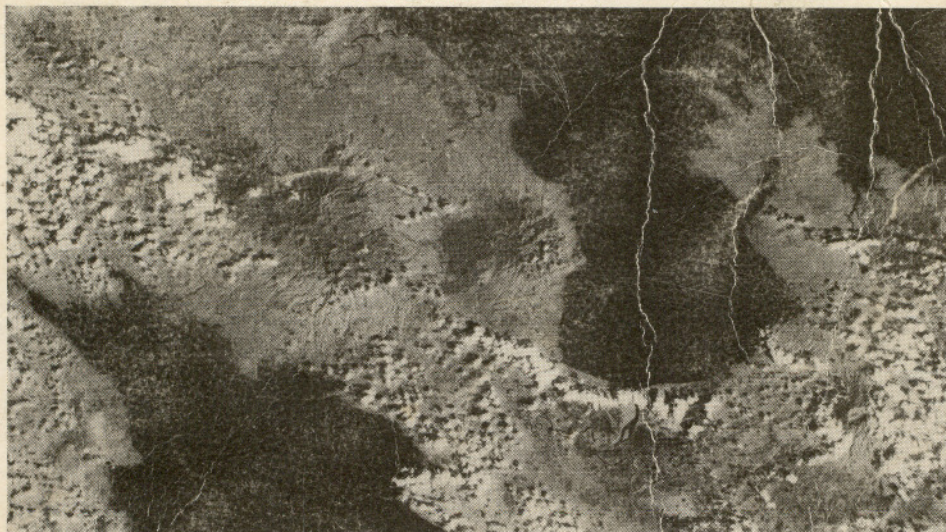



**Small-scale fisheries of  
San Miguel Bay, Philippines:  
options for management  
and research**

*This report is dedicated to  
the small-scale fishermen of San Miguel Bay  
who struggle daily in the face of considerable hardships  
to derive income from their fishing  
sufficient to sustain their families.*



*"Progress [is] the increasing control of  
the environment by life. . . Our problem  
is whether the average man has increased  
his ability to control the conditions of  
his life."*

Will and Ariel Durant, 1968  
The lessons of history.  
Simon and Schuster, New York

# **Small-scale fisheries of San Miguel Bay, Philippines: options for management and research**

Ian R. Smith  
Daniel Pauly  
and  
Antonio N. Mines

1983

**INSTITUTE OF FISHERIES DEVELOPMENT AND RESEARCH  
COLLEGE OF FISHERIES, UNIVERSITY OF THE PHILIPPINES IN THE VISAYAS  
QUEZON CITY, PHILIPPINES**

**INTERNATIONAL CENTER FOR LIVING AQUATIC RESOURCES MANAGEMENT  
MANILA, PHILIPPINES**

**THE UNITED NATIONS UNIVERSITY  
TOKYO, JAPAN**

SH  
207  
TR4  
# 11  
c. 2

JAN 24 '85

**Small-scale fisheries of San Miguel Bay, Philippines:  
options for management and research**

**I.R. SMITH**

**D. PAULY**

**AND**

**A.N. MINES**

**1983**

Published jointly by the Institute of Fisheries Development and Research, College of Fisheries, University of the Philippines in the Visayas, Quezon City, Philippines; the International Center for Living Aquatic Resources Management, Manila, Philippines; and the United Nations University, Tokyo, Japan.

Printed in Manila, Philippines

Smith, I.R., D. Pauly and A.N. Mines. 1983. Small-scale fisheries of San Miguel Bay, Philippines: options for management and research. ICLARM Technical Reports 11, 80 p. Institute of Fisheries Development and Research, College of Fisheries, University of the Philippines in the Visayas, Quezon City, Philippines; International Center for Living Aquatic Resources Management, Manila, Philippines; and the United Nations University, Tokyo, Japan.

Cover: Fishermen of San Miguel Bay with their gill-netters, a small-scale fishing gear.

ISSN 0115-5547

ISBN 971-1022-08-7

ICLARM Contribution No. 138

## Table of Contents

<b>List of Figures</b> .....	vii
<b>List of Tables</b> .....	viii
<b>Preface</b> .....	ix
<b>Executive Summary</b> .....	xi
<b>Abstract</b> .....	1

### PART A: OPTIONS FOR MANAGEMENT

<b>1. Introduction</b> .....	2
<b>2. The San Miguel Bay Fisheries</b> .....	4
FISHING GEAR AND DISTRIBUTION OF OWNERSHIP .....	4
THE CATCH .....	6
ENVIRONMENTAL CHANGES .....	9
DECLINE OF TRAWLABLE STOCKS .....	10
CURRENT LEVELS OF INVESTMENT .....	11
COSTS AND EARNINGS OF MAJOR GEAR TYPES .....	11
VALUE OF CATCH, FISHING COSTS AND RESOURCE RENTS .....	12
SHARING SYSTEMS AND INCOMES OF OWNERS AND CREWMEN .....	18
MARKETING AND MARKETING ORGANIZATIONS .....	22
MIGRATION PATTERNS AND ALTERNATIVE SOURCES OF INCOME .....	23
FISHERMEN'S VIEWPOINT .....	25
CONCLUSIONS .....	25
<b>3. Present Management of San Miguel Bay Fisheries</b> .....	28
HISTORICAL BACKGROUND .....	28
CURRENT STATUS OF THE FISHERY .....	28
JURISDICTION OVER SAN MIGUEL BAY FISHERIES .....	30
<b>4. Management Options</b> .....	36
INTRODUCTION .....	36
ALTERNATIVE MANAGEMENT OBJECTIVES AND INTERVENTIONS .....	39
DISCUSSION OF INTERVENTION MECHANISMS .....	43

<b>A MANAGEMENT INFRASTRUCTURE .....</b>	<b>55</b>
<b>CONCLUSION .....</b>	<b>58</b>

**PART B: RESEARCH OPTIONS**

<b>GENERAL ISSUES .....</b>	<b>60</b>
<b>BIOLOGICAL ANALYSIS .....</b>	<b>66</b>
<b>ECONOMIC ANALYSIS .....</b>	<b>68</b>
<b>SOCIOLOGICAL ANALYSIS .....</b>	<b>70</b>
<b>MONITORING THE FISHERY .....</b>	<b>70</b>
<b>COMMUNICATION OF RESULTS .....</b>	<b>71</b>
<b>INTEGRATION OF RESEARCH AND MANAGEMENT PLANNING .....</b>	<b>72</b>
 <b>Acknowledgements .....</b>	 <b>72</b>
 <b>References .....</b>	 <b>73</b>
 <b>Appendices .....</b>	 <b>79</b>

## List of Figures

1. San Miguel Bay, Philippines. . . . .	3
2. Distribution of catch among the various gear types of San Miguel Bay as estimated by the project economists. . . . .	9
3. The decline of trawlable biomass in San Miguel Bay, Philippines, 1947-1980. . . . .	10
4. Different theoretical yield models and the underlying relationship to the exploited biomass: A: Schaefer's parabolic model; B: Fox's model and C: A flat-topped yield model . . . . .	11
5. Distribution of total value of annual San Miguel Bay catch (P53.5 million in 1980/81) by species groups. . . . .	14
6. Distribution of total value of annual San Miguel Bay catch (P53.5 million in 1980/81) by gear type. . . . .	14
7. Distribution of annual pure profit and losses (resource rents) in thousands of pesos among the various fishing gear types of San Miguel Bay (1980/81) . . . . .	16
8. Distribution of annual costs and pure profits in the San Miguel Bay fishery, 1980-1981 . . . . .	16
9. Typical sharing system of Cabusao gill-netters with boat pilot receiving incentive share from boat owner. . . . .	19
10. San Miguel Bay showing bottom features and major towns and delineation of area where trawling is permitted. . . . .	32
11. Schematic representation of the surface area of San Miguel Bay legally accessible to trawlers below 3 GT (small trawlers) and above 3 GT (medium and large trawlers) . . . . .	33
12. Depth contours in relation to distance from the coastline for San Miguel Bay municipalities, based upon 1907 soundings updated to account for siltation. . . . .	34
13. Relationships between effective effort and total costs and revenues in the multispecies fishery of San Miguel Bay . . . . .	37
14. Flow chart for biological and fishery parameter estimations leading to fishery assessments . . . . .	67



## List of Tables

1. Number of fishing units and ownership patterns of the San Miguel Bay fishery, 1980-1981 . . . . .	6
2. Annual catch and effort by small-scale gears in San Miguel Bay, 1980-1981 . . . . .	7
3. Total annual catch, and large-scale fishery and small-scale fishery catches by taxonomic groups for San Miguel Bay, 1980-1981, as estimated by the project biologists . . . . .	8
4. Levels of investment (pesos) in the San Miguel Bay fisheries (1981) and capital-labor ratios (major gear types) . . . . .	12
5. Annual costs and earnings in pesos of major gear types (per fishing unit, 1980-1981) . . . . .	13
6. Breakdown of 1980-1981 annual San Miguel Bay fishing costs (P50 million) by cost item and fishing gear types . . . . .	15
7. Average monthly fishing days and cash incomes in pesos of owners and crewmen in San Miguel Bay, 1980-1981, by gear type after sharing and payment of all fixed and variable costs . . . . .	21
8. Number of months fishermen in San Miguel Bay spent fishing in the 12 months from February 1980 to January 1981. . . . .	22
9. Prevalence of supplemental occupations among respondent fishermen in San Miguel Bay . . . . .	24
10. Populations of the fishing barrios of the coastal municipalities of San Miguel Bay, 1939-1980 . . . . .	25
11. Summary of data on the San Miguel Bay fisheries, 1980-1981 . . . . .	26
12. Summary of results of the multidisciplinary investigation of the San Miguel Bay fisheries . . . . .	27
13. Summary of major catch and effort statistics of the San Miguel Bay fisheries, 1980-1981 . . . . .	29
14. Summary of municipal ordinances and water depth information by municipality in San Miguel Bay (1982). . . . .	35
15. Alternative management objectives for San Miguel Bay and alternative interventions needed (if any) to address each objective . . . . .	41
16. Intervention mechanisms to limit access and/or effective effort in San Miguel Bay and their likely impact in qualitative terms in the short term and/or long term (relative time) where applicable (and if enforced) and criteria for implementation of management interventions (rated high, medium or low potential to meet criteria) . . . . .	44
17. Data for the computation of an optimum mesh size for the San Miguel Bay trawl fishery . . . . .	48
18. San Miguel Bay Project: major data sources and sampling methodology of stock assessment module. . . . .	63
19. San Miguel Bay Project: data sources and sampling methodology of economics module . . . . .	63
20. San Miguel Bay Project: data sources and sampling methodology of sociology module . . . . .	64
21. Data collected by the stock assessment module. . . . .	65
22. Data collected by the economics module . . . . .	65
23. Data collected by the sociology module. . . . .	66

## Preface

The research project "Small-Scale Fisheries of San Miguel Bay: A Multidisciplinary Analysis" was conducted jointly by the Institute of Fisheries Development and Research (IFDR) of the College of Fisheries, University of the Philippines in the Visayas and the International Center for Living Aquatic Resources Management (ICLARM), both based in Manila, Philippines.

The San Miguel Bay fishery is one of the more important fisheries of the Philippines, being a shallow productive body of water producing large catches of fish, shrimp and other crustaceans. It is located in the Bicol Region of the Philippines near the southern end of the island of Luzon, approximately 400 km south of Manila, the capital city and major market for fishery products.

In addition to the Bay's high biological productivity, there were several other reasons why this site was chosen for an in-depth multidisciplinary study, the first of its kind in the Philippines, if not all of Southeast Asia. The Bicol Region is one of the more depressed areas of the country, with per capita incomes well below the national average. For this reason, and because of the potential for increased production from the agricultural sector, the Bicol River Basin Development Program (BRBDP), an integrated area development plan, was formulated in the early 1970s with the major purpose of building the necessary physical and social infrastructure to bring irrigation to the region's rainfed rice land. With its subsequent responsibilities expanding both geographically beyond the Bicol River basin and administratively to include activities other than rice, the BRBDP became interested in the potential for incorporating fishing into its development planning. The opportunity existed, therefore, for this IFDR/ICLARM research project to provide some of the basic biological and socioeconomic information on the fisheries that would make such planning possible.

Other reasons for selecting San Miguel Bay relate to the biology of the fishery. With a narrow mouth in the north, the Bay sustains what can be identified essentially as a unit fishery, with almost all the fishing activity of residents around the Bay confined to the Bay itself. Moreover, data were available from the 1950s, thus providing a basis for comparison with data collected by this research project, and allowing the researchers to address allegations that the Bay is overfished.

Finally, two major gear types typical of Philippine waters, gill-netters and trawlers, compete for the same stocks within the Bay. This research project was designed to determine the distribution of total catch and revenues among major gear types, so that informed decisions regarding possible gear regulations could be made by the Bureau of Fisheries and Aquatic Resources (BFAR) and the municipalities which have responsibility for enforcing fishery regulations in San Miguel Bay and other fishing grounds of the country.

In addition to funding from IFDR and ICLARM the project received grants from the United Nations University (UNU), Tokyo, Japan and the Philippine Council for Agriculture and Resources Research and Development (PCARRD), Los Baños, Laguna, Philippines. IFDR and ICLARM are both very grateful for this support because the completion of this research project would have been impossible without it.

The project has produced four previous technical reports, jointly published by IFDR, ICLARM and UNU, which cover the biological, economic and sociological aspects of the San Miguel Bay fisheries:

**Pauly, D. and A.N. Mines, Editors. 1982. Small-scale fisheries of San Miguel Bay, Philippines: biology and stock assessment. ICLARM Technical Reports 7, 124 p.** Contains the following papers:

Mines, A.N. The assessment of the fisheries: objectives and methodology.

Mines, A.N., D. Pauly, N.A. Navaluna and J.M. Vakily. The physical environment.

Pauly, D. The fishes and their ecology.

Cinco, E. Length-weight relationships of fishes.

Navaluna, N.A. Morphometrics, biology and population dynamics of the croaker fish, *Otolithes ruber*.

Pauly, D., A.N. Mines and N.A. Navaluna. Catch and effort in the small-scale fisheries.

Vakily, J.M. Catch and effort in the trawl fishery.

Pauly, D. History and present status of the San Miguel Bay fisheries.

**Smith, I.R. and A.N. Mines, Editors. 1982. Small-scale fisheries of San Miguel Bay, Philippines: economics of production and marketing. ICLARM Technical Reports 8, 143 p.** Contains the following papers:

Smith, I.R., A.N. Mines and G. Bañacia. The research site, data collection and methods of analysis.

Yater, F. Gill-netters: costs, returns and sharing systems.

Supanga, N.C. and I.R. Smith. Costs and returns of stationary gears.

Supanga, N.C. Costs and earnings of Cabusao push nets.

Tulay, E. and I.R. Smith. Costs and earnings of mini trawlers.

Navaluna, N.A. and E. Tulay. Costs and returns of small and medium trawlers.

Cruz, W. Institutional and technical aspects of access to municipal fishery resources.

Yater, F., A.E. Esporlas and I.R. Smith. Economic aspects of processing and marketing.

Smith, I.R. and A.N. Mines. Implications for equity and management.

**Bailey, C., Editor. 1982. Small-scale fisheries of San Miguel Bay, Philippines: social aspects of production and marketing. ICLARM Technical Reports 9, 57 p.** Contains the following papers:

Yater, L.R. Field research methodology and general characteristics of fishing families.

Esporlas, A.E. The seasonality of fishing, marketing and processing.

Villafuerte, E.D. and C. Bailey. Systems of sharing and patterns of ownership.

Yater, L.R. The fisherman's family: economic roles of women and children.

Yater, L.R. Problems in the fishery as perceived by the fishermen.

**Bailey, C. 1982. Small-scale fisheries of San Miguel Bay, Philippines: occupational and geographic mobility. ICLARM Technical Reports 10, 57 p.**

This, the fifth and final technical report synthesizes the complementary findings of the first four reports above, discusses the need for managing the San Miguel Bay fisheries and outlines optional management mechanisms and research approaches.

The specific results presented in this final report are drawn primarily from the first four technical reports of the project and the 23 papers therein. Citation of these individual papers is omitted to avoid repetitious disruptions in the text.

DR. I.R. SMITH  
Director  
Traditional Fisheries Program  
ICLARM

PROF. A.N. MINES  
Project Leader and Director  
IFDR

## Executive Summary

Competition for access to and use of coastal fish resources in much of the tropics have noticeably increased in recent decades. Areas that traditionally have been the sole preserve of artisanal or small-scale fishermen using such time-tested techniques as hook and line, traps and gill-nets have come under increased pressure from modern gear types. Nowhere has the resulting competition for a limited resource been stronger than in coastal trawlable grounds where valuable shrimps are found.

### SAN MIGUEL BAY

One such fishing ground is San Miguel Bay in the Bicol region of the Philippines (Fig. A). The Bay is a large shallow estuary, becoming shallower over the years. Until World War II it had been fished primarily by such fixed gears as filter nets and traps and a limited number of mobile fishing units that included four Japanese beam trawlers. Over the last four decades, the level of fishing effort significantly increased. In part this was from motorization of much of the non-trawl fleet and from a steady 2% per annum growth in numbers of fishermen. However, most was from increases in the number of trawlers; there are currently almost 100 small trawlers operating in the Bay.

These "baby" trawlers, as they are called, range from two to five gross tons (GT), and most are registered as "municipal" fishing craft, hence under Philippine law are considered small scale. Technically speaking the upper limit to the "municipal" category is 3 GT. Commercial fishing using vessels larger than 3 GT is banned from within 7 km of the coastline in many Philippine provinces, including those of Bicol where San Miguel Bay is located. "Baby" trawlers can fish legally in waters deeper than 4 fathoms (7.3 m), and this requires permission from local municipalities. Otherwise they must stay in waters beyond 7 fathoms (12.8 m) deep.

Including "baby" trawlers with their 100-125 hp diesel engines in the same category as un-motorized gill-netters, for example, certainly masks the fundamental differences between these gear types and makes control over trawling activities extremely difficult, if not impossible. With no enforcement, however, they routinely trawl throughout the Bay, regardless of depth.

The result of the historical increase in effort in the Bay is a situation characterized by:

- full biological exploitation;
- reduced profits in the fishery as a whole and even losses for some non-trawl gears;
- highly uneven distribution of catch and incomes in favor of trawlers; and
- outmigration of fishing community labor in search of higher incomes elsewhere.

Petitions by various fishermen groups have been sent to national authorities which in 1982 resulted in a Presidential decree banning all large-scale commercial trawlers (those registered as over 3 GT) from the Bay. This ban affected only a limited number of trawlers; fishermen's complaints against the "baby" trawlers have continued and been aired repeatedly in a local magazine, *Balalong*. The non-trawl fishermen are particularly critical of the common practice of registering trawlers bigger than 3 GT as municipal craft and they have threatened "to enforce the ban themselves even at the risk of violence" (*Balalong*, 3 June 1983).

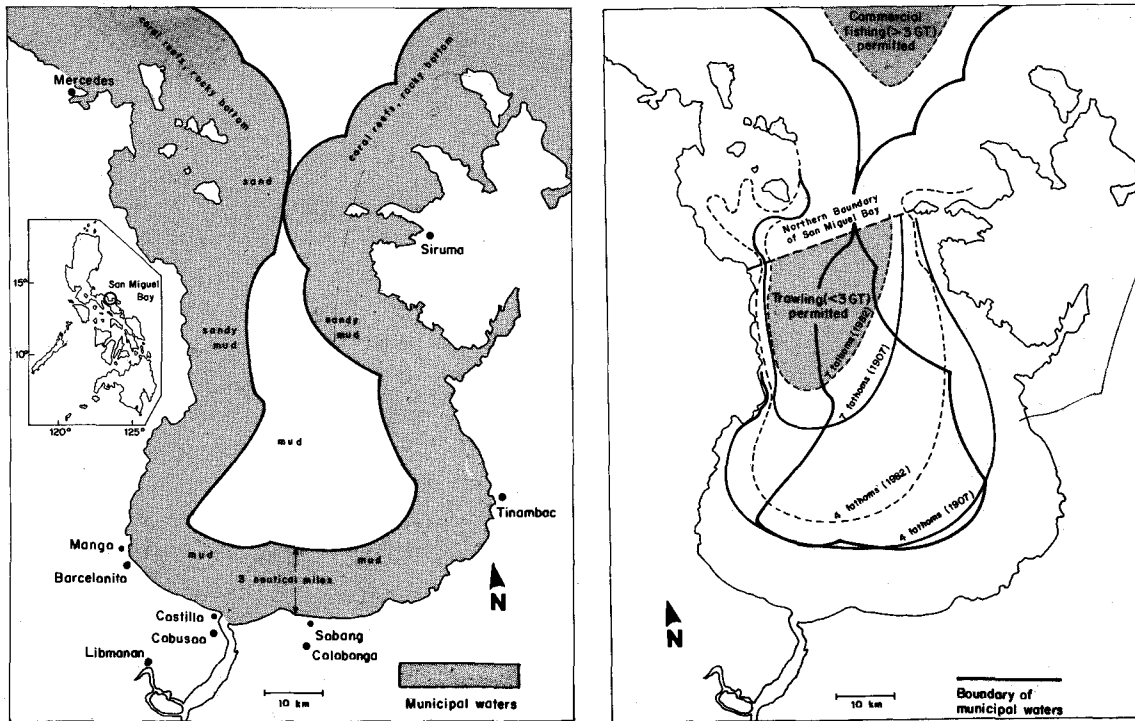

Fig. A. *Left*: San Miguel Bay showing bottom features and major towns. Municipal waters are shaded. Central portion of the Bay is under jurisdiction of national fisheries authorities. *Right*: Delineation of areas where trawling is permitted is complicated by the gradual shallowing of the Bay which puts most of the trawling grounds outside the municipal waters.

In the account that follows, the trawling fleet is separated from true small-scale fishing gears to highlight and quantify the differences between them.

#### RESEARCH STUDY

San Miguel Bay was the site of an intensive multidisciplinary three-year research project conducted by the Institute of Fisheries Development and Research (IFDR) of the University of the Philippines in the Visayas (UPV) and ICLARM to document the conditions of the fisheries and fishing communities there so that these communities could be integrated into the development planning of the Bicol River Basin Development Program (BRBDP).

The research project had three parts, biology, economics and sociology, and has been reported in a number of papers, most of which are included in five Technical Reports published jointly by IFDR and ICLARM, with the United Nations University and the Philippine Council for Agriculture and Resources Research and Development providing partial funding. The research project not only documented prevailing biological and sociological conditions, but also evaluated a range of management options for the fisheries of San Miguel Bay.

#### FINDINGS

Catches from the Bay were found to be three to four times higher than reported in official statistics. The total catch is about 19,000 tonnes, of which 4,000 t consist of *balao*, a tiny shrimp. They are captured by small motorized craft called mini-trawls; there are some 190 of these essentially small-scale units manned by about 400 fishermen which constitute a discrete fishery. Of the



remainder, 15,000 t, 60% is caught with a variety of small-scale (non-trawl) traps and seines by over 5,000 fishermen and 40% by 95 trawlers of various sizes. Apart from the *balao* fishery, there is considerable competition among gear types for the major species caught. Historical data obtained from various research boats and commercial trawlers were also used for comparative purposes (Fig. B). The results show dramatic increases in effective effort and declining trawlable biomass but are consistent with a total catch that is levelling off. (The continued high catch from the Bay is possibly due to the fact that the large-size slow-turnover species have been replaced by smaller, fast-turnover species.) Detailed stock assessments using a variety of mathematical models suggest that the Bay is overfished in the sense that an increase in effort by either the trawl or the small-scale fishery would not result in an increased catch from the San Miguel Bay as a whole.

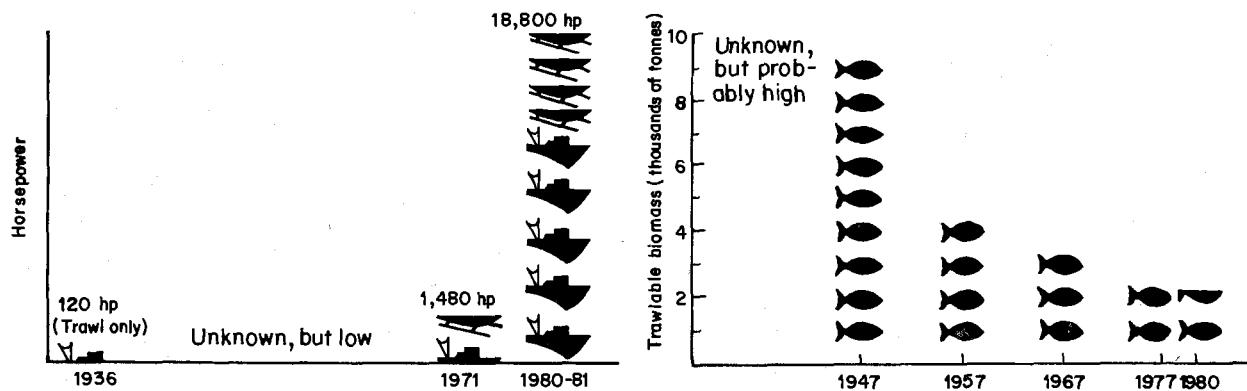

Fig. B. The evolution of effort (horsepower only) and stock size (trawlable biomass only) from 1936 to 1981 (based on various sources).

Extreme competition for use of the resource and uneven distribution of benefits were shown by the economic analysis. The "baby" trawlers, representing only 3% of the Bay's fishing units and employing 7% of the fisheries' labor force, earn the largest share of catch value and 50% of that part of the profits (revenues exceeding all costs, including a "fair" return to capital) from the fishery that accrue to fishermen.

The government tax on fuel and the fuel suppliers-cum-fish processors also divert part of the profits from the fishermen. However, trawlers, which use diesel fuel, have been able to maintain their competitive edge over small-scale gears (which if motorized use regular gasoline) because the government tax on regular fuel (P2.54/l) at the time of the study was five times that on diesel fuel. If trawlers had to pay the same fuel tax as the small-scale "fleet", they would have operated at a loss in 1980-81. This finding provides evidence to support the view that industrial fisheries are often subsidized directly or indirectly while small-scale fisheries are not. Though lower taxes on diesel fuel are viewed by the national government as conducive to industrialization in the economy as a whole, they have had a negative effect on small-scale fisheries. Adding to the problem is that continued expansion of the trawl fleet can be expected as long as the average trawl unit continues to be profitable, as was the case in 1980-81.

The sociological analyses indicated that the ownership and earnings of the trawlers are highly concentrated: five families own 50% of the trawler fleet. In contrast, the small-scale "fleet", consisting of approximately 2,300 fishing units, is dispersed among approximately 2,000 households. The investigations also revealed that very limited alternative employment opportunities exist in the vicinity of the Bay, which explains the low earnings of labor both within the fishery and outside as well as the significant rate of outmigration from the Bicol area. Outmigration has not been sufficient, however, to offset population growth.

All perspectives of the San Miguel Bay fisheries, including those of fishermen themselves, lead to the same conclusion (see Table A): the Bay is sorely in need of management. The increasing problems of overfishing and uneven distribution of benefits can only be minimized if steps are taken to limit the amount of fishing effort. Continued credit programs are unlikely to solve the problems of the small-scale fishermen unless steps are taken to regulate those gear types with which they compete. Even then, the growth of fishing communities and expected future entrants to the non-trawl fishery imply that any partial attempt to control fishing effort in the Bay will only be "buying time." Regardless of time frame, management of the fisheries is required.

#### MANAGEMENT OPTIONS

If steps are taken to limit fishing effort in San Miguel Bay, not all current users can be accommodated. Any management intervention and reallocation of use rights will be inherently political in nature because management would redistribute current and future incomes earned from the San Miguel Bay fisheries. Such a move is likely to be objected to by those among the current users who would be adversely affected.

Because of the sensitive nature of these issues, the San Miguel Bay research team evaluated a full range of management options. Provided here are several options with their advantages and disadvantages (see Table B). Further details can be found in the main body of the report. Any management measure adopted would depend upon the prior selection of the management objectives. If the major objective would relate to maintaining or even increasing incomes of the majority of the Bay's users rather than promoting the most economically efficient (i.e., profitable) gear type, some limitation on the trawling fleet should be considered.

Although a whole range of management interventions was considered, most did not seem appropriate or enforceable for a multispecies multigear fishery such as in San Miguel Bay. For example, fleet or individual quotas, taxes, seasonal closures and price controls were all viewed as impractical for one reason or another. Mesh-size restrictions (i.e., increasing mesh size), while potentially useful in the short run, were thought to be difficult to enforce and because they control only one component of fishing effort, are not a long-term solution to the Bay's problems. Finally adjusting the diesel/regular gasoline fuel tax differential would not be practical given the government's broader development objectives for non-fishing sectors.

Trawlers presently pay only nominal license fees. One option for limiting their activities would be to increase these fees, either setting them higher or auctioning them off with limits to the number any one individual can take. This option, coupled with strict enforcement of existing area restrictions, would probably be most effective for reducing trawl fishing effort. Also, a licensing scheme could earn significant income (resource rents) for the licensing authorities which could (should) be used for income-generating activities in the coastal communities of the Bay. There is evidence that non-trawl gear types would fill the niche vacated by any trawlers that may be excluded, thus increasing small-scale catch and incomes in the short term at least.

Longer-term solutions that would deal with the problem of population growth and thus growing numbers of fishermen necessitate looking outside the fisheries sector.

One of the major constraints to management of the Bay is the overlapping jurisdiction of local and national authorities and legislation. Confusion over *who* potentially controls *what* has been the result. Treating all trawlers as a distinct gear type separate from small-scale gears, and then controlling their activities, would be a good first step to reduce this confusion.

#### A MANAGEMENT PARTNERSHIP

However, more than this is necessary to guarantee success of any attempt to manage the fisheries of San Miguel Bay. If fishermen themselves do not participate in any aspect of the planning or implementation of management of the fisheries, one can be certain that circumvention of any

Table A. Summary of results of the multidisciplinary investigation of the San Miguel Bay fisheries.

Stock assessment		Economics		Sociology/mobility	
Ecosystem description	Ecology of fishes described. Silt deposition of 2.5 cm/yr estimated	Costs and earnings	Reported for each major gear type, investment costs, costs and earnings, determinants of catch, and returns to owners and crew according to various sharing system practiced. Showed that for some gears (esp. small trawlers), owners and crew earn significantly more than their opportunity costs, while most non-trawl fishermen do not.	Ownership patterns and sharing system	Little concentration of ownership for non-trawl gears, highly concentrated for trawlers. Kinship important for non-trawl gears; less so for trawlers. Diverse sharing systems determined by kinship and alternative income opportunities.
Catch	Annual catch (1980-81) estimated to be 19,000 t, including sergestid shrimp. From species composition by gear type, extent of competition among gear types established.	Total costs and value of catch	Total annual value of catch (1980-81) estimated to be approximately P53 million; total costs to be approximately P50 million (valuing fuel at its market price). Distribution of value among competing gear types established.	Role of women	Women control family finances and have important role in fishing investment decisions; women dominate marketing system.
Fishing effort	Horsepower in fisheries increased from 1,500 hp (1971) to 18,800 hp (1980).	Fishing incomes	For non-trawl fishery, crewmen incomes range from P164-218 monthly; P339-699 monthly for trawler crewmen. Only small trawler owners earn enough to place them above poverty threshold.	Fishermen's perceptions of resource	Three-quarters believe average catch declining: 1/3 blame trawlers; 1/4 blame increase in all categories of fisherman; 1/4 don't know reason.
Trawlable biomass	Estimated using surplus yield models to have declined from 8,900 t (1947) to 1,650 t (1980) indicating overexploitation.	Resource rents (pure profits) in the fishery	Share of resource rents being earned by each major gear type was estimated. Concentration of current resource rents in the hands of a small number of trawlers was demonstrated. Most of the small-scale non-trawl gears were earning little or no resource rents; therefore there was a very skewed distribution of benefits from the fishery. The government earned a major share of the rents through its tax on fuel. Processors/fuel suppliers earned a small share through oligopsony/oligopoly power and lower prices paid for catch.	Marketing system	Important socioeconomic role of "suki" system of favored buyer, seller and mutual help implied.
Yield per area	22.8 t/km <sup>2</sup> including sergestid shrimp. Used to suggest that increased effort will not increase catch.	Extent of over-fishing	Increases in effort will add to costs, further dissipate remaining resource rents and reduce incomes for majority of fishermen.	Occupational and geographic mobility	Forty-five percent of respondents willing to move to different municipality to take up different occupation, 39% willing to move to different province, willingness cuts across all groups by age, education and asset ownership, 88% want their children out of fishing.
Extent of overfishing	Available evidence suggests that the Bay is overfished in the sense that an increase in effort by either the trawl or non-trawl fishery would not result in increased catch, but rather exacerbate the present allocation problems between the trawl and non-trawl fisheries.	Performance and economies of scale in wholesale market	No significant economies of scale found for processors. In target communities, a small number of processors control the bulk of the volume handled, and entry barriers are high.	Migration	Significant outmigration but insufficient to reduce numbers of fishermen. Females more likely to migrate out than males.
		Performance and economies of scale in retail market	No significant economies of scale or entry barriers in fresh or dried fish marketing from target communities. Large number of middlewomen earn only slightly more per day than the fishermen from whom they buy.	Alternative occupations	Prospects of full-time local alternatives very dim; some hope of supplementary income through small-scale animal husbandry and commercial-agriculture.
				Implications for raising incomes	Short-term solution requires re-allocation of benefits from fishery, long-term solutions must be sought outside fishery.

regulations chosen will be the rule. It is critically important in this fishery, as elsewhere, that a management partnership be forged between fishermen and the local and national officials with responsibilities in the fisheries sector. The research team's proposed solution is the creation of a San Miguel Bay Fisheries Authority.

Such an Authority would have responsibility for setting management objectives for the whole Bay, collecting the background information necessary for selecting management steps, as well as implementing, monitoring and enforcing them.

The fishermen, both small-scale and trawler operators, must participate in decisionmaking by this Authority if it is to deal successfully with the twin problems of overfishing and inequitable distribution of benefits that currently exist in San Miguel Bay.

Lack of fishermen's participation will most likely subvert any management plan; indeed, some measure of local decisionmaking and enforcement offer much better hope for fisheries management than do nationally centralized attempts at regulation.

#### THE BROADER PROBLEM

The general features of what the research team has learnt about the San Miguel Bay fisheries apply to a large number of other fisheries throughout the Philippines, various Southeast Asian countries and, to a lesser extent, to many other tropical developing countries.

It was conflict of interest similar to that in San Miguel Bay, but involving much larger numbers of trawlers and small-scale fishermen, which prompted the Indonesian government to ban trawling in that country. Other conflicts of this kind, often violent, have been reported from various parts of the Indo-Pacific. The lesson seems to be that in tropical demersal fisheries—because they generally involve shrimps that are caught inshore—conflicts between trawl operators and small-scale fishermen are almost unavoidable in the long run; projects of the type conducted in San Miguel Bay are indispensable for clarifying the issues involved and outlining some of the possible remedies.

Table B. Alternative management objectives for San Miguel Bay and alternative interventions needed (if any) to address each objective.

Alternative objectives	Alternative interventions
A. Objectives related to harvest sector	
● Increase sustainable yield	Maximum yield probably achieved under current conditions, but stabilization of effort or control over size at first capture (e.g., increase minimum mesh size) required to avoid long-term decline in trawlable biomass and further changes in species composition.
● Increase economic efficiency (i.e., resource rents)	Encourage innovation and progressiveness to reduce fishing costs. Substantial reduction in effort and costs required; numerous specific interventions can be considered (e.g., quotas, licenses, taxes, selective price controls, area or seasonal closures). Decision also needed as to which gear types should be regulated and whether to leave increased rents in the fishery or to extract for use by institutions other than fishermen.
● Increase employment in fishing	Restrict capital-intensive gear types; maintain most of the current large-mesh nets of the small-scale fishery and increase some others; allow continued unrestricted entry of small-scale fishermen; continue subsidized credit for small-scale labor intensive gear types.
● Provide conditions conducive to more equitable distribution of income (a) between labor (crewmen) and capital (owners); and	(a) No intervention in current sharing arrangements necessary as present systems appear responsive to respective opportunity costs; labor share can be increased by increasing labor opportunity costs; encourage owner-operator fishing and discourage multiple ownership to make more crewmen become owners.

Table B. Continued

Alternative objectives	Alternative interventions
(b) among competing gear types	(b) Restrict certain gear types, especially small trawlers; introduce parity in taxes on inputs, especially gasoline and diesel fuel.
● Reduce conflicts between the large-scale and small-scale sectors	Enforce existing legislation; redefine 'municipal' fisheries to exclude small trawlers, then limit small-trawler numbers or areas of operation or ban them; establish trawling barriers in areas off limits to trawlers.
● Raise incomes of fishing households above the poverty threshold	Given prevailing low incomes throughout Bicol, long-term increases in fishing household incomes possible only through combination of (a) limited entry that excludes some fishermen thus benefitting those that remain, (b) alternative/supplementary income generation; short-term increases possible by subsidizing inputs or reducing taxes thereon (e.g., gasoline tax) used by small-scale fishermen; and (c) education programs that increase skills and mobility of fishing families.
● Reduce environmental impact of activities in and near the Bay	Siltation inflows due to upland agriculture activities, while causing gradual shallowing and reduction in Bay's area, also bring nutrients of probable benefit to the fishery; halt conversion of mangroves to alternative uses (e.g., fishponds).
● Increase government revenues from the fishery	Increase municipal license fees, taxes on inputs, catch and/or incomes so as to extract increased resource rent in favor of the government (municipal, provincial, regional or national).
● Increase production of exportable species to earn foreign exchange	No major intervention necessary; present conditions (e.g., siltation, fishing out of predators and trawling) are favorable to shrimp production. Increasing mesh size may increase average size of shrimps caught but would not necessarily increase total catch or catch value.
<b>B. Objectives related to fisheries inputs and marketing sectors</b>	
● Improve technical and economic efficiency of input supply, processing and marketing sectors	Encourage use of standard weights and measures; increase flow of price information from local markets to beach landings through channels other than those controlled by middlemen; improve landing and auction facilities, encourage better product handling and processing techniques; improve fuel supply and market roads to more remote communities.
● Increase opportunities for village employment in the input supply, processing and marketing sectors	Decentralize and increase number of processing establishments; provide credit to small-scale processing entrepreneurs; encourage community organizations to undertake group processing and marketing and organize the appropriate group (i.e., women, not men) to undertake these activities.
<b>C. Objectives related to the regional economy</b>	
● Provide sufficiently attractive alternative income sources, . . . so as to reduce dependence upon fishing	General economic development and diversification in the Bicol Region to increase the presently low opportunity costs of fishing labor and capital; land reform for rice and non-rice land; investment incentives to decentralize Manila-based development; strengthening of local and regional institutions and delegation of authority to them. Specific activities for fishing communities may include small-scale agro-industry such as pig farming.
● Maintain social and political stability in the fishing communities surrounding San Miguel Bay	Generate local employment opportunities to reduce rural-urban migration; restrict certain efficient capital-intensive gear types viewed by the majority of fishermen as detrimental to their interests; strengthen military presence to keep "peace and order" or establish management institutions that permit fishermen involvement in decision-making regarding resource use and allocation.



## **Small-Scale Fisheries of San Miguel Bay, Philippines: Options for Management and Research**

SMITH, I.R., D. PAULY AND A.N. MINES. 1983. Small-scale fisheries of San Miguel Bay, Philippines: options for management and research. ICLARM Technical Reports 11, 80 p. Institute of Fisheries Development and Research, College of Fisheries, University of the Philippines in the Visayas, Quezon City, Philippines; International Center for Living Aquatic Resources Management, Manila, Philippines; and the United Nations University, Tokyo, Japan.

### **Abstract**

This report synthesizes the respective research findings of the biology, economics and sociology modules of a multidisciplinary study of the small-scale fisheries of San Miguel Bay, Philippines and examines various options for management of this very productive multispecies multigear fishery.

The report highlights (1) the lack of potential for further expansion of the fishery; (2) the competition in resource use that prevails between 2,300 small-scale gears on the one hand, and 95 trawlers on the other hand; (3) the highly skewed distribution of benefits from the fishery between these two groups; and (4) the limited alternative employment opportunities available locally to the majority of the Bay's small-scale fishermen.

The need for the creation of management institutions and mechanisms that control the level of effective fishing effort in the Bay and that address the equity issues related to distribution of benefits from the fisheries is stressed. The trade-offs among various management options, including those that limit the fishing effort of trawlers, are explored. It is recommended that a San Miguel Bay Fisheries Management Authority be established and that fishermen participate in all decisionmaking regarding management of the Bay's resources.

Finally, the methodologies used for data collection and interpretation during the course of the study are discussed in the context of the information requirements necessary for managing a complex fishery such as that in San Miguel Bay.

# Part A. Options for Management

## 1. Introduction

The original general objective of this research study was to document the biological, economic and sociological conditions prevailing in the fisheries and fishing communities of San Miguel Bay (Fig. 1) so these fishing communities could be integrated into the development planning for the Bicol Region of the Philippines. Specific objectives of each discipline involved in the study flowed from the overall objective. These specific objectives were as follows (Maclean 1980):

- *Biology (stock assessment)*: to assess the status of the fishery resources of San Miguel Bay.
- *Economics*: to determine catch, effort and incomes of municipal fishermen, costs and returns for the major municipal fishing gears and the economic efficiency of the marketing and distribution system.
- *Sociology*: to examine the nature of the flow of human resources between municipal fisheries and other rural sectors and to assess the potential of programs that seek to reduce the dependence of fishing households on capture fishing (occupational and geographic mobility study); to determine the economic role of women and children; to examine the factors that influence sharing systems for the major municipal gear types; and to describe sociological aspects of the marketing system and the effect on it of seasonal changes in catches.

The Bicol Region where San Miguel Bay is located has one of the lowest per capita income levels among all regions of the country (NEDA 1982), and consequently the national government is making a concerted effort through its Bicol River Basin Development Program to raise employment and incomes in the area. Fishermen, moreover, have been identified as constituting one of the poorest sectors within Bicol (USAID 1980). The original overall objective of this research study, related to integrated rural development planning, had an inherently long-term focus in terms of its examination of ways in which incomes in fishing communities could be raised.

Implied in such a goal is the belief that there are linkages and resource flows between fishing communities and non-fisheries sectors that can be influenced or changed in some fashion to the benefit of fishing communities, their income levels and standards of living. Indeed, this research project has shown that in the long run, the solutions to low levels of income in fishing communities that fish fully exploited resources will emanate primarily from outside the fisheries sector per se; that is, economy-wide economic growth and development will be necessary.

This long-term approach, however, provides little immediate consolation for fishermen in Bicol. As the research progressed during 1979-1982, it gradually took on an added dimension that focused more directly on the San Miguel Bay fisheries, the current pattern of resource exploitation and potential short-term solutions to the twin problems of overfishing and low incomes for the Bay's small-scale fishermen. It became apparent that the fishery itself, which has both trawl and non-trawl components and has been alleged to be overfished (Simpson 1978), could potentially be managed in such a way that benefits derived from fishing could be distributed more equitably in favor of the majority of fishermen.

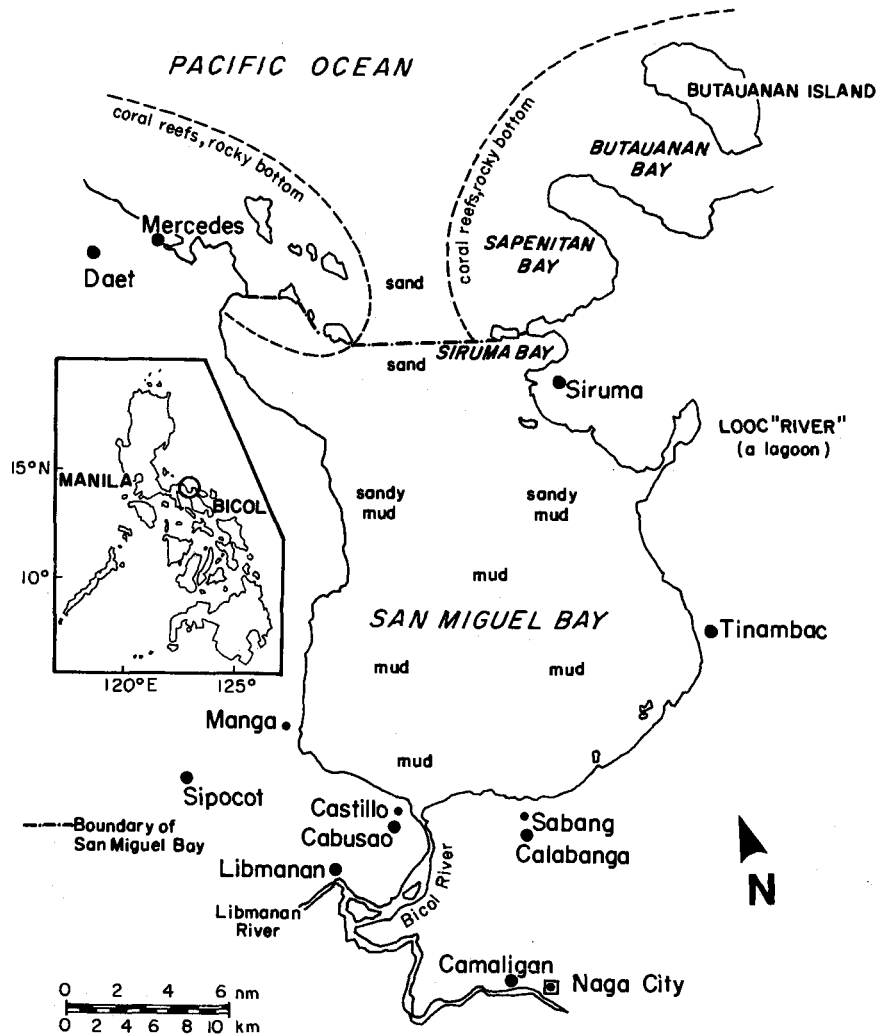

Fig. 1. San Miguel Bay, Philippines.

Traditional approaches to problems of poverty in small-scale fisheries sectors have focused upon technical solutions (e.g., upgrading of gears) in the belief that increases in income could be gained by increasing the productivity of individual fishermen. However, when resources are already fully exploited, technical improvement of benefit to some but not all fishermen will most likely exacerbate inequalities in income distribution rather than provide a solution to the poverty of the many (Smith 1979). A focus on technical solutions was apparent in the Philippines during the 1970s when credit schemes and programs of cooperative development were launched to facilitate technical improvements in the small-scale coastal fisheries of the country (Smith et al. 1980). For example, San Miguel Bay fishermen received a substantial number of loans during this period and there was considerable expansion in fishing effort as the gill-net fleet subsequently became motorized. Simultaneously, the Bay's fleet of trawlers also rapidly expanded.

By 1980, however, changes began to occur in the widely held perception that the Philippine coastal resources could sustain further expansion in fishing effort. Indeed, concern about overfishing in several major fishing grounds, including San Miguel Bay, had been raised as early as the mid-1970s.

The Integrated Fisheries Development Plan of the Philippines for the 1980s prepared by the Fishery Industry Development Council (FIDC) was the first official public recognition of the limitations to further expansion of Philippine fisheries:

Present harvest is estimated to be 1.6 million MT out of an estimated potential yield of RP (Republic of the Philippines) waters placed at 1.65 million MT  $\pm$  200,000 MT (FIDC 1981).

More recent government statements indicate seriousness of intent and awareness of the need for management or limitations on effective fishing effort, and also recognition of the difficulties ahead:

Because of the reported depletion of resources in internal waters and, more recently, the reported decline in tuna catch, the government has realized the crying need for national fisheries management. The (current) development plan proposes the adoption of a selective licensing scheme for fishing vessels which will limit their operations in specific areas. The implementation of limited entry will be hindered by opposition from fishermen unused to being regulated and by the very limited enforcement capability (Samson 1982).

Management of a fishery implies some degree of control over access to or use of the resource, and in the case of multispecies fisheries where several gear types may be competing for the same stocks, this control may benefit one group of fishermen at the expense of another. These trade-offs between competing groups of fishermen are of special concern when stocks are already fully exploited.

Under such circumstances, fishery managers must take into account not only the stock assessment findings of biologists and the economics of the fishery, but also the considerations of sociologists regarding the potential impact on fishermen and fishing communities of any change in the prevailing distribution of assets and income. In other words, the information required for managing such a fishery must be drawn from multidisciplinary data and perspectives.

Moreover, because control over the fishery will affect the distribution of benefits derived from fishing, fishery management programs have an overt political element. An analogous situation exists in Philippine agriculture where land reform programs and their size limitations (7 ha) for rice and corn farms have produced a partial shift in asset distribution in that sector. Whether mandated from the national government or resulting from local deliberations involving affected groups, fishery institutions cannot avoid the distributional and hence political impact of their management decisions.

Within the social sciences there is debate among professionals as to whether researchers should simply state what *is* or rather proceed to recommend what *should be*. Because of the inherent political nature of fishery management decisions, the research staff of the IFDR/ICLARM San Miguel Bay project take the position that "the facts should speak for themselves." Thus, this report contains (1) statements of the biological, economic and sociological findings of the study; (2) discussion of their implications regarding the need for control over fishing effort; (3) presentation of management options in the context of alternative management objectives, and (4) discussion of the advantages and disadvantages of each. The primary purpose of this report is thus to outline management options and not to provide management recommendations.

## 2. The San Miguel Bay Fisheries

### FISHING GEAR AND DISTRIBUTION OF OWNERSHIP

The fisheries resources of San Miguel Bay are exploited by various gear types, most of which are classified in the Philippines as "municipal" gears. By definition the "municipal" category includes all vessels less than 3 gross tons (GT) and all fishing gear for which no vessel is required. All vessels over 3 GT are considered "commercial" and are licensed by the Bureau of Fisheries and Aquatic Resources (BFAR). This legal distinction groups together under the 'municipal' label such diverse gears as small trawlers, gill-netters and handliners. Although perhaps suitable for licensing purposes which mandate municipal licensing of all vessels smaller than 3 GT, this distinction between

“municipal” and “commercial” is arbitrary and inadequate for purposes of analysis of the multigear San Miguel Bay fishery.

For the purposes of this management study, gears used in San Miguel Bay were classified into three categories:

1. *Small-scale non-trawl gears*, which range from simple handlines to tidal weirs. There were nearly 2,100 units in San Miguel Bay in 1980. They mainly catch demersal and small pelagic fish. Investment costs per fishing unit (gear and vessel, if applicable) in 1980/81 were ₱250-13,000.\*
2. *Small-scale trawl gear*, which includes one class of vessels only—the mini trawler or *itik-itik*. A total of 188 mini trawlers were present in 1980. They are used almost exclusively to catch a small sergestid shrimp, *balao*. Average 1980-81 investment cost for vessel and gear, ₱9,200.
3. *Large-scale trawl gear*, which includes three classes of trawlers—*small* (< 3 GT), *medium* (3-10 GT) and *large* (> 10 GT but usually > 100 GT). The small and medium groups comprise 95 units. Their main target is shrimp but demersal fish constitute the majority of the catch. Investment costs in 1980-81 ranged from ₱55,000 for small trawlers to ₱70,000 for medium trawlers. Large trawlers are not considered further as their fishing grounds are outside the Bay, though they occasionally trawl as they pass through the deeper areas near the mouth of the Bay.

The above distinction between small scale and large scale can also be thought of in terms of investment costs; small scale are those with investment costs less than ₱20,000 in 1980. A small trawler (investment cost = ₱55,000) is thus a large-scale gear.

In terms of the BFAR regulations, categories 1 and 2 are “municipal” as are the small trawlers of category 3. These small trawlers which are also known as “baby” trawlers in the Philippines, may be permitted by the various municipalities to fish in shallow waters of the Bay, deeper than 4 fathoms (7.3 m); otherwise, they are legally required to work in waters deeper than 7 fathoms (12.8 m). At the time of data gathering, medium and large trawlers were also required to fish in waters deeper than 7 fathoms but in February 1982 commercial fishing (vessels > 3 GT) was totally banned from San Miguel Bay.

Details of ownership are shown in Table 1. The 2,300 small-scale fishing units are owned by approximately 2,000 households. Although there is some concentration of ownership of fixed gears, small-scale gear ownership is widely disbursed. A total of 1,500 households own no fishing unit, however. In contrast, small and medium trawlers averaged three per owner-household. However, ownership was even more concentrated; almost 50% of the trawlers were owned by five families.

Prior to World War II, few fishing vessels in the Philippines were motorized and Umali (1937) reports only three Japanese beam trawlers of 40 hp each operating in the Bay in 1936, or a total of 120 hp. By 1980-81, total horsepower had increased to an estimated 18,800 hp. Most of this increase has occurred since 1972 when the first small and medium trawlers were introduced. Of this horsepower, 70% or 13,200 hp is installed in small and medium trawlers with the balance, 5,600 hp, divided between mini trawlers and motorized gill-netters.

In the mid-1970s, the Philippine government initiated several major credit programs for municipal fishermen, often tied to the formation of fishermen’s cooperatives or associations (Smith et al. 1980). A major line of credit was the Small Foreshore and River Fishermen Program of the Development Bank of the Philippines. This program operated for five years and made loans exceeding ₱279 million until its suspension in 1978 due to extremely low repayment rates nationwide (< 5%). A total of approximately ₱4.5 million was lent to 1,206 municipal fishermen in San Miguel Bay for the purchase of small boats (*bancas*), marine engines, and fishing gear accessories. The bulk of the

---

\*In 1981, ₱8.0 = US\$1.0.



Table 1. Number of fishing units and ownership patterns of the San Miguel Bay fishery, 1980-1981.

Gear type (local name)	No. of fishing units		
	(Non-trawl)	Small-scale fishery (Trawl)	Large-scale fishery (Trawl)
Scissor net ( <i>sakag</i> )	634		
Hook and line ( <i>banwit</i> )	424		
Gill-net ( <i>panke</i> ) <sup>a</sup>	350		
Mini trawl ( <i>itik-itik</i> ) <sup>b</sup>		188	
Stationary liftnet ( <i>bukatot</i> )	171		
Fish pot ( <i>bubo</i> )	106		
Longline ( <i>kitang</i> )	103		
Fish corral ( <i>baklad</i> )	89		
Small trawler ('baby' trawl; <i>panquerna</i> )			75
Crab liftnet ( <i>bintol</i> )	71		
Filter net ( <i>biakus</i> )	60		
Spear gun ( <i>antipara</i> )	51		
Medium trawler ('baby' trawl; <i>panquerna</i> )			20
Mobile bagnet ( <i>basnig</i> ) <sup>c</sup>	17		
Beach seine ( <i>sinsoro</i> )	11		
Fish weir ( <i>sabay</i> )	5		
Round haul seine ( <i>sapyao</i> )	4		
Stationary tidal weir ( <i>ambak</i> )	2		
Cast net ( <i>dala</i> )	1		
Total no. of units		2,287	95
Total no. of owners		2,030	35
Total no. of households		3,500	N.A. <sup>e</sup>
Total no. of fishermen		5,100	500 <sup>d</sup>

<sup>a</sup>This is the general term: see Table 2 for further description.

<sup>b</sup>This gear is treated as small scale separately from the small and medium trawlers because of its much lower investment cost and the special nature of the resource it exploits (see p. 5).

<sup>c</sup>Fish primarily outside the San Miguel Bay.

<sup>d</sup>Excluding owners who do not fish.

<sup>e</sup>N.A.—not available (trawler crewmen were not surveyed by household).

gill-net fleet was motorized during this period, and the mini-trawl fleet greatly expanded. By 1981, the replacement value of the entire fleet of motorized trawl and non-trawl vessels and gear together exceeded ₱15 million.

In contrast to the recent rapid increase in capital inputs to the fishery, the fishing labor force has been growing at a slower rate of 2% per annum. Consequently, the capital intensity of the gears used has increased considerably during the past decade.

#### THE CATCH

As for any fishery, the identity of the stock(s) exploited by the fishermen around San Miguel Bay had to be established before inference could be made on the impact of fishing on the resource. San Miguel Bay is an estuary, and as such harbors a demersal fish fauna consisting predominantly of euryhaline fishes. The rocky outcrops and coral reefs at the mouth of the Bay are characterized by a different fauna consisting predominantly of reef fishes, such as Serranidae, Acanthuridae and Chaetodontidae, which are very sparsely represented within the Bay itself (Herre 1953). Thus, although detailed fish community studies were not conducted, it was possible to separate the fish stocks within San Miguel Bay proper from other adjacent multispecies stocks.

A major effort was directed toward obtaining figures from which the total catch from the Bay could be estimated. A combination of secondary data from the Bureau of Fisheries and Aquatic Resources (BFAR) and the Philippine Fish Marketing Authority (PFMA) and extensive primary data collected by the research teams was used to estimate 1980-81 total catch. Because PFMA and BFAR data covered only large-scale trawlers and also appeared incomplete, the catch and effort data collected from operators of the major trawl and non-trawl gears during the course of the project formed the core of the data used in assessing the status of the San Miguel Bay fisheries. Both the biology (stock assessment) and economics teams made total catch and catch per gear estimates.

The biology team's estimate of annual total catch based on various data sets spanning approximately two years beginning in early 1980 was 19,133 t of which 4,473 t were sergestid shrimp or *balao* caught primarily by the mini trawlers (Tables 2 and 3). Of this total, 580 t (3%) was estimated

Table 2. Annual catch and effort by small-scale gears in San Miguel Bay, 1980-1981, as estimated by the project biologists.

Gear	Total no.	Annual no. of trips of each gear	Annual no. of trips of all gear	Catch per trip (kg)	Total annual catch <sup>a</sup> (t)	Major groups caught <sup>b</sup> (%)
Gill-net						
<i>Panke</i>	300	234	70,200	46	3,229	<i>Otolithes ruber</i> (48.6), Sciaenidae (29), misc. spp. (8.73)
<i>Palataw</i>	470	115	54,050	11.4	616	Mugilidae (52.9), Sciaenidae (22.5), misc. spp. (15.3)
<i>Pamating</i>	30	94	2,820	4.95	14	Sharks and rays (48.7), misc. spp. (38.1), <i>Arius thalassinus</i> (8.11)
<i>Pangasag</i>	257	174	44,718	5.78	258	Crabs (85.8), misc. spp. (12.1), Sciaenidae (1.70)
<i>Palubog</i>	288	162	46,656	15.8	737	Mugilidae (65.2), <i>Sardinella</i> spp. (34.4), Crabs (0.234)
Liftnet ( <i>bukatot</i> )	171	53	9,063	68.8	624	<i>Stolephorus</i> spp. (79.8), misc. spp. (9.07), <i>Sardinella</i> spp. (7.65)
Filter net ( <i>biakus</i> )	60	225	13,500	21.85	295	<i>Stolephorus</i> spp. (45.5), Leiognathidae (19.8), <i>balao</i> (11.2), misc. spp. (15.0)
Fish corral ( <i>baklad</i> )	89	209	18,601	28.5	530	Misc. spp. (41.8), Crabs (18.0), Sciaenidae (13.5)
Mini trawl ( <i>itik itik</i> )	188	191	35,908	133.1	4,779	"Balao" (88.5), misc. spp. (6.7), shrimps (4.7)
Scissor net ( <i>sakag</i> )	634	150	95,100	5	476	"Balao" (50), shrimps (50)
Longline ( <i>kitang</i> ) <sup>c</sup>	103	120	12,360	2	25	Carangidae (20), Pomadasydae (20), misc. spp. (60)
Hook and line ( <i>banwit</i> ) <sup>c</sup>	424	120	50,880	4	204	Misc. spp. (100)
Crab liftnet ( <i>bintol</i> ) <sup>c</sup>	71	132	9,372	3	28	Crabs (100)
Fish trap ( <i>bubo</i> ) <sup>c</sup>	106	120	12,720	4	51	Misc. spp. (100)
Spear gun ( <i>antipara</i> ) <sup>c</sup>	51	156	7,956	4	32	Pomadasydae (25), misc. spp. (75)
Fish weir ( <i>sabay</i> ) <sup>c</sup>	5	168	840	72	60	Shrimps (50), misc. spp. (50)
Stationary tidal weir ( <i>ambak</i> ) <sup>c</sup>	2	144	288	7	2	Mugilidae (33), misc. spp. (67)
Beach seine ( <i>sinsoro</i> ) <sup>c</sup>	11	308	3,388	80	271	Carangidae (34), <i>Sardinella</i> spp. (33), <i>Stolephorus</i> spp. (33)
					Total 12,231	

<sup>a</sup>Total catch, including 4,472 t of "balao" (sergestid shrimp).

<sup>b</sup>Major groups only; totals therefore do not add up to 100%. See Table 3 for other groups.

<sup>c</sup>Based on information provided by A.E. Esporlas. Names in parentheses are in Bicol language.

Table 3. Total annual catch, and large-scale fishery and small-scale fishery catches by taxonomic groups for San Miguel Bay, 1980-1981, as estimated by the project biologists.

Taxonomic group	Total annual catch (t)	Catch (t) by:		% caught by:	
		Large-scale fishery	Small-scale fishery	Large-scale fishery	Small-scale fishery
Sharks and rays	45	36	9	79.9	20.1
<i>Stolephorus</i> spp.	2,100	1,369	731	65.2	34.8
<i>Sardinella</i> spp.	795	201	594	25.3	74.7
<i>Arius thalassinus</i>	44	6	38	13.0	87.0
Mugilidae	1,190	330	860	27.7	72.3
<i>Otolithes ruber</i>	2,004	409	1,595	20.4	79.6
Sciaenidae (excluding <i>O. ruber</i> )	1,468	313	1,155	21.3	78.7
Pomadasyidae	34	21	13	61.5	38.5
Carangidae	269	57	212	21.3	78.7
Leiognathidae	112	38	74	33.8	66.2
Trichiuridae	324	254	70	78.5	21.5
<i>Scomberomorus commersoni</i>	75	28	47	37.9	62.1
Miscellaneous species	4,406	3,018	1,388	68.5	31.5
Squids	250	235	15	93.9	6.1
Crabs	500	120	380	24.0	76.0
Penaeid shrimps	1,044	461	583	44.2	55.8
Sergestid shrimps ( <i>balao</i> )	4,473	0	4,473	0	100.0
Total catch	19,133	6,896	12,237	36.0	64.0

to be caught by large commercial trawlers near the mouth of the Bay. The total area of San Miguel Bay is 840 km<sup>2</sup> so this catch represents a yield of 22.6 t/km<sup>2</sup>, comparable to some of the highest yields per unit area recorded for bays in Texas (Saila 1975) and for coral reef fisheries (Marshall 1979; Alcalá 1981).

The economics team independently estimated total catch for a slightly different time period (June 1980 to May 1981) using different data collection methods. For example, the biologists used a 1.5 power factor to relate medium trawler catches to those of small trawlers, while the economists, using record-keeping data, showed that medium trawlers caught 1.11 times as much as small trawlers during their reference period.

Both groups depended in part upon catch estimates for minor small-scale gears provided by the sociology team from data collected during its household survey. The economists' estimate of total catch (which did not include that of large trawlers) was very close to the biologists' estimates—18,967 t, of which 4,781 t or 25.2% was *balao* caught by mini trawlers; small and medium trawlers caught 30.6% of total catch and the small-scale non-trawl gears caught the remaining 44.2% (Fig. 2). Previous investigators ignored the small-scale catch and thus certainly underestimated the total catch.

Besides documenting the high productivity of this body of water (on a per area basis) the data in Tables 2 and 3 encapsulate the major characteristic of the San Miguel Bay fisheries; namely that the large-scale and small-scale fisheries essentially compete for the same resources.

The small-scale fishery is generally much more selective than the large-scale fishery, but, with the exception of the *balao*, all resources in Table 2 are exploited simultaneously by both fisheries. Indeed, the interaction between the two fisheries is much stronger than suggested by Table 3 as much of the catch of the small and medium trawlers consists of the young of all other groups which are exploited more or less selectively as adults by the small-scale non-trawl fishery.

This latter feature, incidentally, appears very important in San Miguel Bay, because the commonly held assumption that non-trawl fisheries catch young fish while trawlers catch bigger fish is totally inapplicable; indeed, the converse is true.

Single-species assessments were conducted for an important first-class fish (the croaker, *Otolithes ruber*), three species of anchovies (*Stolephorus* spp.) and the penaeid shrimps. The results suggest that the small mesh size (which may be as small as 8 mm when trawlers fish for anchovies) used by the small and medium trawlers, combined with the high fishing mortality (see below) that is now prevailing in the Bay have a negative effect on yields, and that a significant increase of mesh sizes would probably increase the catches of these fish and shrimps. Because the fish and shrimps of San Miguel Bay interact biologically through competition and predation, however, the increase of a

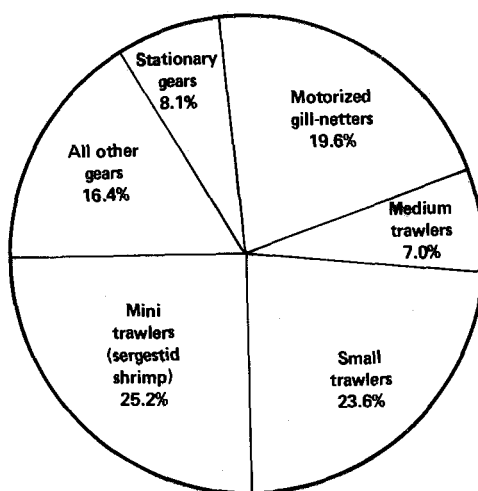

Fig. 2. Distribution of catch among the various gear types of San Miguel Bay as estimated by the project economists.

resource produced by a reduction of its fishing mortality could result in the decrease of an even more valuable resource via increased predation. The data at hand suggest, for example, that the reduction of certain low value fish such as the Leionathidae (*sap-sap*) has led to an increase in catches of shrimps.

#### ENVIRONMENTAL CHANGES

Even such simple inferences as those above regarding shifts in species composition are not without problems, however, because the Bay itself has changed over recent decades. Changes in species composition could be due to siltation as well as to changes in fishing pressure. A bathymetric survey conducted in mid-1980 revealed that the Bay is now markedly shallower than is suggested by comparison with the most detailed nautical chart presently available, which is based on soundings made mainly in 1907. It is estimated that a minimum rate of silt deposition of 2.4 cm/year has occurred. This confirmed a trend suggested by the observable fact that landing places in Sabang, Calabanga, previously accessible to small trawlers are now so shallow that the catch has to be dragged on flat-bottom boats across extensive mudflats. On the other hand, the extremely high productivity of the Bay undoubtedly is due in part to the high volume of nutrient-bearing silt that is deposited in the Bay from the Bicol River.

The implications of the siltation of the Bay are numerous but can be grouped into practical and legal implications.

The practical implications pertain to the fact that with large tracts of the Bay becoming too shallow for trawling, fixed gears become attractive again, a feature which should mitigate the effects of increasing fuel prices. Another practical implication of the increased siltation of the Bay is that

directly or indirectly it should have a marked effect on the productivity of the Bay, and on the species composition of its benthic communities.

The legal implication of the rapid siltation of the Bay relates to the regulation that excludes small trawlers from waters shallower than 7 fm (or 4 fm if specifically permitted by the municipality concerned). The last decades have seen substantial reduction of the area of San Miguel Bay legally accessible to small trawlers.

#### DECLINE OF THE TRAWLABLE STOCKS

Since the first trawling survey was conducted in San Miguel Bay in 1947, research vessels have repeatedly conducted exploratory fishing in the Bay. Also, several agencies have occasionally monitored catches of privately-owned trawlers. Consequently, historical catch data on a per haul basis are available for the period 1947-1980. The estimates of apparent density ( $t/km^2$ ) derived from these data indicate that there has been a significant decline in the trawlable stocks since 1947 to less than 20% of their original value, from  $10.6 t/km^2$  in 1947 to  $2.0 t/km^2$  in 1980 (Fig. 3). Trawlable biomass as used here is defined as the biomass accessible to the large-scale (trawl) fishery and explicitly excludes *balao* which is not caught by the small, medium and large trawlers.

The estimated catch of large-scale trawlers for the period June 1980-May 1981 of approximately 6,000 t was 3.6 times the estimated trawlable biomass. This value is similar to estimates made for the Gulf of Thailand (Pauly 1979a). This means that on the average, each square kilometer of San Miguel Bay is effectively swept by trawlers three and a half times each year. That the small biomass can sustain this high effective effort and production is an indication of the high turnover rate of the stocks.

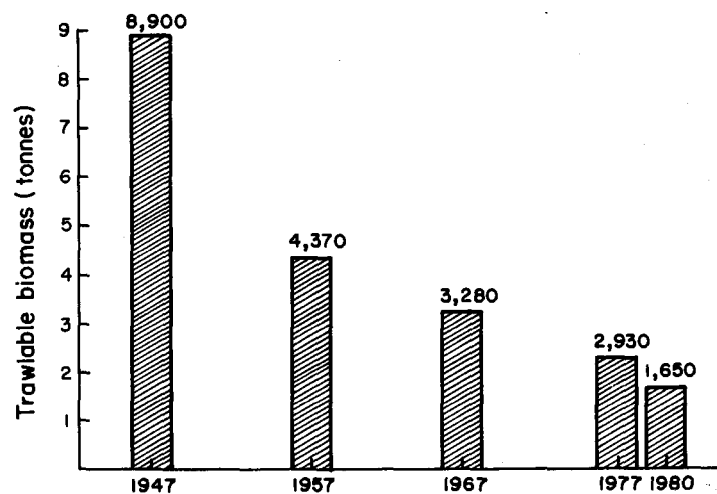

Fig. 3. The decline of trawlable biomass in San Miguel Bay, Philippines, 1947-1980. Adapted from Pauly (1982).

Most models used in stock assessment are for single species stocks and they suggest overfishing occurs when standing stock is reduced to values of 50-40% of virgin stock (Figs. 4A and 4B). These models also suggest that once overfishing has occurred, catches could be increased through a reduction of fishing effort. Because of the multispecies nature of the fishery, however, the yield-effort relationship for the San Miguel Bay fishery is probably more or less flat-topped (Fig. 4C), such that a reduction of overall effort would not necessarily lead to an increased total catch. By the same token, of course, increases in fishing effort will also not lead to higher total catch.

However, because of the strong interaction in terms of species caught between the large-scale fishery and the small-scale non-trawl fishery, a reduction of effort by either one of these two fisheries would lead to an increased catch of the other fishery as can be seen in Fig. 4C. For this reason,

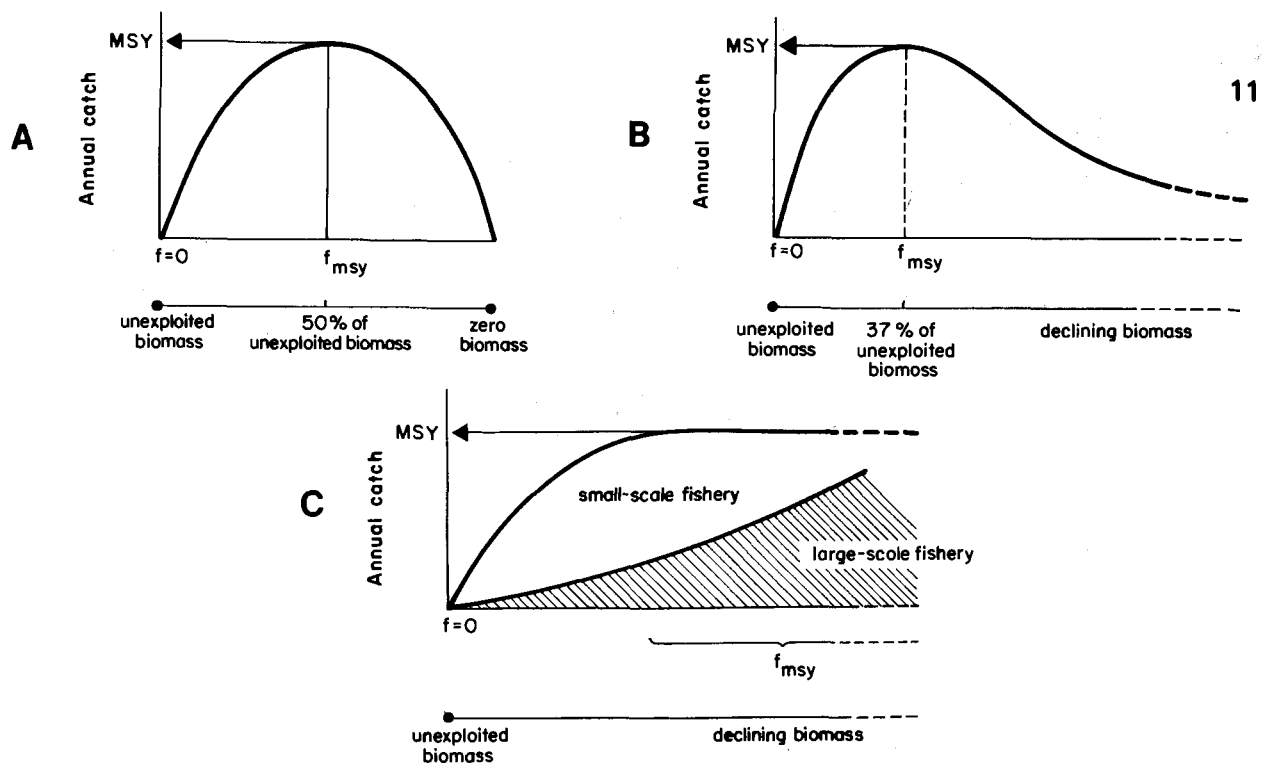

Fig. 4. Different theoretical yield models and the underlying relationship to the exploited biomass: A: Schaefer's parabolic yield model which was developed for single-species fisheries and implies MSY at a biomass corresponding to 50% of the unexploited biomass, and a level of effort which drives the stock to extinction. B: Fox's model, which implies MSY at a biomass corresponding to 37% of the unexploited biomass, and a much reduced, but non-zero catch at very high levels of effort (see Ricker 1975 for Schaefer's and Fox's models). C: A flat-topped yield model is thought to be appropriate for tropical multispecies fisheries (see Larkin 1982). No single level of effort generates "MSY" because the total yield, over the range of effort that is applied in a developed fishery neither increases nor declines markedly. Note that this model does not exclude a "transfer" of part of the catch from one sector of the fishery to another, as illustrated here (see also Pauly 1982).

effort reduction in the San Miguel Bay fishery is more a question of resource allocation among competing users (i.e., a socioeconomic or political question) than a question of preventing biological overfishing.

#### CURRENT LEVELS OF INVESTMENT

The 2,382 fishing units that operated in San Miguel Bay in 1980-81 represented a significant level of investment (Table 4). Two-thirds of this amount was invested in the small-scale (non-trawl plus mini trawler) fleet; one-third in large-scale trawlers. However, the capital-labor ratios were considerably higher in the latter. To create a job in the small and medium trawl fishery costs over P10,000 or 2-3 times as much as it does to create one job in the non-trawl fishery. Labor intensity, however, does not necessarily imply profitability as the costs and earnings analysis showed small trawlers to be more profitable than the small-scale fishery. This difference in profitability, however, was due to a differential in the fuel tax paid by the two fleets (see p. 14 for further discussion).

Still, the data in Table 4 indicate the extreme disparity in levels of investment per fishing unit between small- and large-scale gears and the problems that arise from grouping all these gears under a single "municipal fisheries" label. The P55,000-P70,000 investment required for small and medium trawlers is well beyond the means of most small-scale fishermen and far exceeds the usual lending limit (P15,000) of the rural banks under the various credit programs of the government.

#### COSTS AND EARNINGS OF MAJOR GEAR TYPES

Daily trip data from 64 fishing units were collected for 12 months, June 1980-May 1981, to determine the costs and earnings of the major gear types operating in San Miguel Bay. The results reported here represent data from a total of 11,248 fishing trips by these major gear types (scissor

Table 4. Levels of investment (pesos) in the San Miguel Bay fisheries (1981) and capital-labor ratios (major gear types).

Gear type	1981 Replacement cost	No. of units	Total investment	Crew size	Capital-labor ratio
<b>Large-scale fishery</b>					
Small trawler	55,000	75	4,125,000	5	11,000:1
Medium trawler	70,000	20	1,400,000	6	11,667:1
Subtotal			5,252,000		
<b>Small-scale fishery</b>					
Gill-netter (non-motorized)	2,800	150	420,000	2	1,400:1
Gill-netter (motorized)	13,000	350	4,550,000	3	4,333:1
Mini trawl	9,200	188	1,729,600	2	4,600:1
Fish corral	9,100	89	809,900	2	2,550:1
Liftnet	12,200	171	2,086,200	4	3,050:1
Filter net	3,500	60	210,000	1-2	2,333:1
Scissor net	250	634	158,500	1	250:1
Subtotal			9,964,200		
Total investment <sup>a</sup>			15,489,200		

<sup>a</sup>Excluding 645 miscellaneous minor gears for which no economic data were collected.

nets, motorized gill-nets, stationary liftnets, fish corrals, filter nets, mini trawlers, small trawlers and medium trawlers).

Costs and earnings of these major gears are summarized in Table 5 on a per-fishing-unit basis. After deducting all operating, fixed, variable and opportunity costs from the value of their catch, scissor nets, stationary liftnets and medium trawlers incurred losses in 1980-1981. Gill-netters, the most common of the mobile non-trawl gears, earned negligibly more than all costs. Fish corrals, mini trawlers and especially small trawlers earned large pure profits.

#### VALUE OF CATCH, FISHING COSTS AND RESOURCE RENTS

Extrapolating to the fishery as a whole based on prices received by fishermen, it was determined that the total annual value of the catch in the period under study was ₱53.5 million, of which ₱50.5 million was costs and ₱3 million was pure profit or positive resource rents\* (Table 6). Over one-half of the annual value of the catch came from shrimps and squids (Fig. 5). Almost 42% of the value of the catch was earned by small and medium trawlers (Fig. 6). Similarly, over 50% of the pure profits were earned by the small trawlers with mini trawlers earning much of the rest (Fig. 7). Liftnets were unable to cover their costs, though this may be due to bad weather having delayed the beginning of the liftnet season in 1981.

As with the catch, the distribution of the catch value and profits is highly skewed towards the large-scale trawlers. Since only 35 families owned the 95 large-scale trawlers (5 families owned 40 units), compared to 2,287 small-scale fishing units owned by 2,000 households, there was significant concentration of benefits from the San Miguel Bay fisheries.

Theoretical considerations would suggest that all resource rents would be dissipated in an open-access fishery such as San Miguel Bay. That this has not yet occurred may be due to some barriers to entry and particularly to the rate at which entry has taken place. Fish corrals may have benefitted

\*Resource rents represent the difference between total revenues from the fishery and the total costs of fishing.

Table 5. Annual costs and earnings in pesos of major gear types (per fishing unit, 1980-1981).<sup>a</sup>

	Gear types studied							
	Scissor net	Motorized gill-net	Stationary liftnet	Fish corral	Filter net	Mini trawler	Small trawler	Medium trawler
Annual value of catch	607	32,900	10,000	16,200	7,700	38,500	228,700	254,400
Less operating costs deducted before sharing								
• fuel (gasoline, kerosene and LPG)	n/a	11,700	3,800	1,600	100	17,200	89,300	128,900
• oil	n/a	300	50	0	0	500	600	2,000
• parts, repair, maintenance	n/a	1,300	200	150	300	600	9,700	7,900
• food and others (cigarettes, etc.)	150	3,600	700	700	700	3,500	14,200	17,600
• hired labor	n/a	n/a	n/a	2,900	n/a	n/a	n/a	n/a
• ice	0	0	0	0	0	0	9,400	11,400
Subtotal	150	16,900	4,750	5,350	1,100	21,800	123,200	167,800
Net revenue before sharing	457	16,000	5,250	10,850	6,600	16,700	105,500	86,600
Net income of owners <sup>b</sup>	457	7,700	2,350	10,850	3,300	7,100	65,300	60,100
Less costs borne by owners								
• fixed costs <sup>c</sup>	57	3,700	5,450	5,650	1,500	1,650	21,400	30,800
• variable costs <sup>d</sup>	0	700	0	0	0	200	23,700	27,500
• opportunity costs <sup>e</sup>	440	3,400	1,300	1,300	700	2,450	8,300	10,900
Owner's pure profit (or loss)	(40)	(100)	(4,400)	3,900	1,100	2,800	11,900	(9,100)
Net income of crewmen <sup>f</sup>	n/a	8,300	2,900	2,900 <sup>g</sup>	3,300	9,600	40,200	26,500
Less labor opportunity costs of crew <sup>h</sup>	n/a	7,600	2,700	3,400	3,200	4,800	25,200	28,700
Crew's pure profit (or loss)	n/a	700	200	(500)	100	4,800	15,000	(2,200)
Pure profit (or loss) per fishing unit <sup>i</sup>	(40)	600	(4,200)	3,400	1,200	7,600	26,900	(11,300)

n/a: not applicable

<sup>a</sup>All figures rounded off (except for scissor net).<sup>b</sup>Includes income from owner's share of net revenue, and in the case of small and medium trawlers, includes income from broker's fee and engine maintenance reserve.<sup>c</sup>Includes depreciation, licenses and other fees.<sup>d</sup>Includes engine, vessel and gear maintenance expenses which are not charged before sharing.<sup>e</sup>Includes opportunity costs of non-fishing owner's investment capital, own labor and family labor (if applicable).<sup>f</sup>Includes share of net revenue for all boat pilots, *maestros*, machinists and ordinary crewmen as appropriate.<sup>g</sup>Represents hired labor expenses already deducted before sharing.<sup>h</sup>See Smith and Mines (1982) for derivation of these labor opportunity costs.<sup>i</sup>The sharing system allows some of the rent (pure profits) to be passed on to the crew (see Nahan 1982 for another example).<sup>j</sup>Sum of owner's and crew's pure profit (or loss).



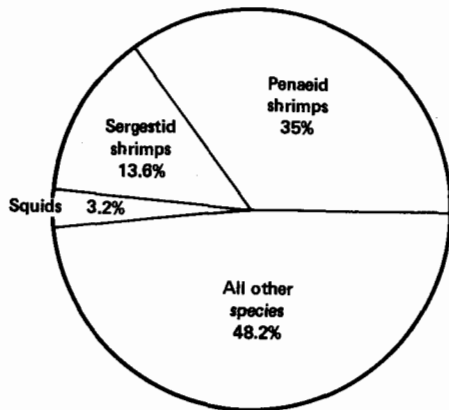

Fig. 5. Distribution of total value of annual San Miguel Bay catch (P53.5 million in 1980/81) by species groups.

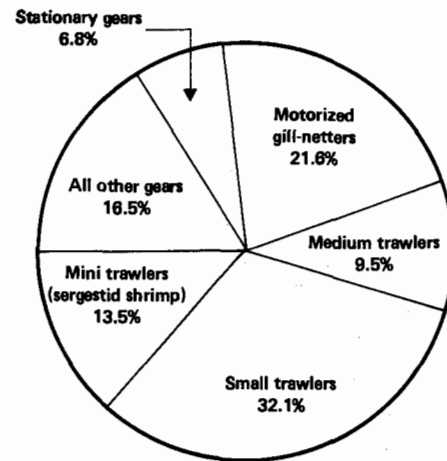

Fig. 6. Distribution of total value of annual San Miguel Bay catch (P53.5 million in 1980/81) by gear type. Not included here is the value of fishermen's take-home catch nor the oligopoly/oligopsony profits of fuel suppliers/fish processors.

from entry barriers in the sense that only limited numbers can be accommodated and at least in some locations, senior or elder fishermen known as *amonojadors* still play an allocative function. The high investment costs limit the rate of growth of the small trawler fleet. The fact remains that further expansion in the effective effort of the fleet is likely to dissipate that portion of the remaining profits that accrues to fishermen.

The pure profits shown in Table 6 and Fig. 7 represent those accruing to the fishing fleet. In addition, fuel suppliers/processors and the Philippine government earned pure profits from the San Miguel Bay fishery in 1980-1981.

Operating costs made up 56% of the costs of the San Miguel Bay fishery (Fig. 8), of which almost two-thirds were for fuel expenses. Fuel prices increased twice during the period of study and fishermen complained of being caught between declining catches and increasing fuel costs. Many small-scale fishermen obtained gasoline on credit from gasoline suppliers (who double as processors) in return for agreements to sell their catch to them at reduced prices. Significant oligopoly/oligopsony\* profits were being earned by these suppliers/processors who were thus capturing a share of the resource rents. The P53.5 million annual value of the fishery is based upon prices received by the fishermen; gasoline suppliers' share of the resource rents which may be as high as P2 million would increase the value of the fishery, and of course influence the distribution of benefits derived therefrom.

Almost one-third of the fuel/oil expenditures of fishermen consists of government taxes. In 1981, these taxes were approximately 45% (P2.54/l) on regular gasoline which the Briggs and Stratton engines of the gill-netters and mini trawlers use and 14% (P0.46/l) on the diesel fuel used by the small and medium trawlers. Total annual fuel expenditures were P18.5 million, of which approximately P5.5 million represent taxes. The diesel/gasoline tax differential is part of a package of incentives that the Philippine government has adopted to promote industrialization.

The revenue generated by these fuel taxes is used by the government for road construction, energy exploration and special projects; theoretically, then, some of the tax revenues could be used for the benefit of fishing communities among other groups in the population at-large. Part of the tax can also be rebated to the refineries to cover their losses due to currency exchange fluctuations

\*Limited numbers of sellers and limited numbers of buyers with consequent abilities to influence prices in their favor.

Table 6. Breakdown of 1980-1981 annual San Miguel Bay fishing costs (P50 million) by cost item and fishing gear types.

Costs	All fishing units									Totals
	Scissor nets	Motorized gill-nets	Stationary liftnets	Fish corrals	Filter nets	Mini trawlers	Small trawlers	Medium trawlers	All other gears <sup>a</sup>	
No. of fishing units	634	350	171	89	60	188	75	20	795	2,382
<b>Variable costs</b>										
Fuel/oil	0	4,200,000	658,350	142,400	6,000	3,327,600	6,742,500	2,618,000	846,400	18,541,250
Repair and maintenance	0	700,000	34,200	13,350	18,000	150,400	2,505,000	708,000	1,354,240	5,483,190
Ice	0	0	0	0	0	0	705,000	228,000	0	933,000
Food and miscellaneous	95,100	1,260,000	119,700	62,300	42,000	658,000	1,065,000	352,000	1,184,960	4,839,060
Subtotal variable costs	95,100	6,160,000	812,250	218,050	66,000	4,136,000	11,017,500	3,906,000	3,385,600	29,796,500
<b>Fixed costs</b>										
Depreciation, licenses and fees	36,138	1,295,000	931,950	502,850	90,000	310,200	1,605,000	616,000	1,777,440	7,164,578
<b>Opportunity costs</b>										
Owner's capital and labor	278,960	1,190,000	222,300	115,700	42,000	460,600	622,500	218,000	1,015,680	4,165,740
Crew labor <sup>b</sup>	0	2,660,000	461,700	302,600 <sup>c</sup>	192,000	902,400	1,890,000	574,000	2,285,280	9,267,980
Total all costs	410,198	11,305,000	2,428,200	1,139,200	390,000	5,809,200	15,135,000	5,314,000	8,464,000	50,394,798
Pure profits (loss)	(25,360)	210,000	(718,200)	302,600	72,000	1,428,800	2,017,500	(226,000)	0	3,061,340
Total value of catch	384,838	11,515,000	1,710,000	1,441,800	462,000	7,238,000	17,152,500	5,088,000	8,464,000	53,456,138

<sup>a</sup>Since many of these other gears are used from non-motorized *bancas*, the total costs (which were derived from total catch and average price received of P2.87/kg) and assuming zero (pure profit) have been divided 10% to fuel/oil; 16% to repair and maintenance; 14% to food and miscellaneous; 21% to fixed costs; 12% to owners' opportunity costs; and 27% to crew labor opportunity cost. All percentages except for fuel/oil and ice are interpolated from the distribution of these costs for those gear types for which complete cost records were obtained.

<sup>b</sup>Includes opportunity costs of owners' labor in those cases where fishing unit is owner-operated.

<sup>c</sup>Opportunity cost of hired laborers each of whom is actually paid P10 daily (P2,900 per fishing unit per year) or P258,100 total.

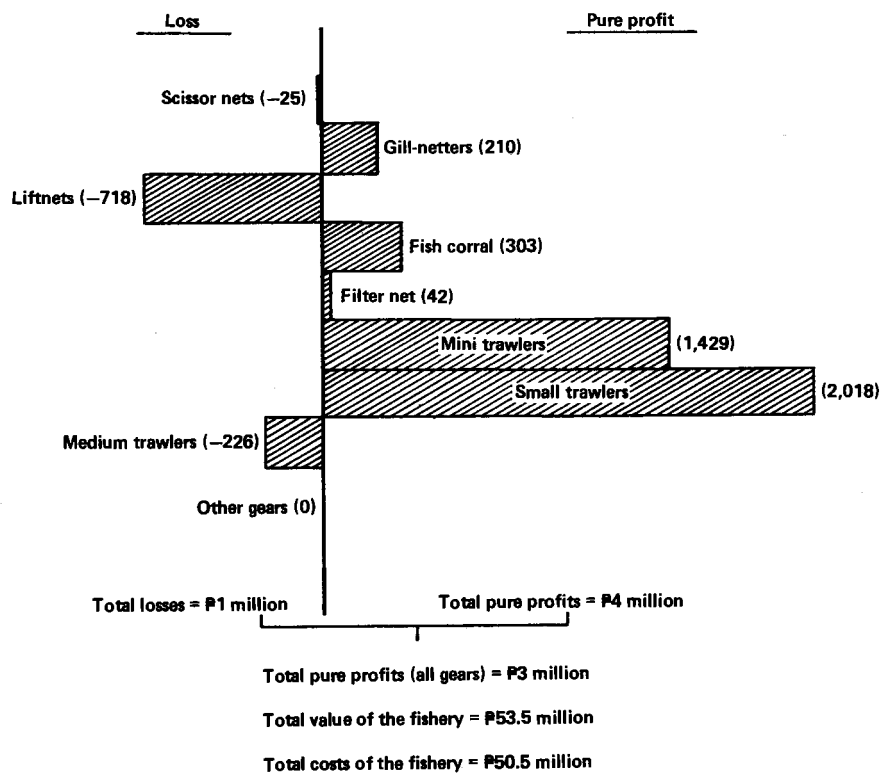

Fig. 7. Distribution of annual pure profits and losses (resource rents) in thousands of pesos among the various fishing gear types of San Miguel Bay (1980/81).

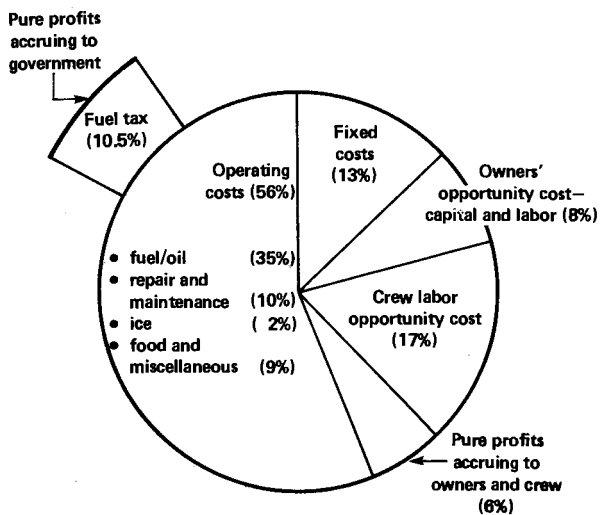

Fig. 8. Distribution of annual costs and pure profits in the San Miguel Bay fishery, 1980-1981 (total ₱53.5 million; 63% of operating costs is for fuel and oil; 30% of these expenditures are in the form of fuel taxes which represent the government's share of pure profits (resource rents).

and increased prices of crude oil. Product prices at the refinery in 1981 were almost identical: ₱2.52 (gasoline) and ₱2.47 (diesel) not including government taxes or various delivery charges (Caltex head office, Manila, pers. comm.). Retail prices of fuel are fixed by the government. The crude cost equalization differential, as the rebate to refineries is called, can be no more than ₱0.96/l (gasoline) and ₱0.17/l (diesel). The differential however, is not necessarily rebated in full to refineries by the government.

The Philippine government thus earned approximately ₱5.5 million resource rents from the San Miguel Bay fisheries. In addition, because of the higher tax rate on regular gasoline than on

diesel, the small and medium trawlers were indirectly subsidized in comparison to the non-trawl and mini trawl fishermen, further skewing the benefits in favor of those that already have the larger share of catch, catch value and profits on a per-fisherman and per-fishing unit basis. If small trawlers had to pay the same tax on diesel as do those small-scale gear types using gasoline, the average small trawler would have incurred losses of approximately ₱30,600 rather than pure profits of ₱26,900.

Given the price differentials between diesel and gasoline fuels, why have non-trawl fishing units not converted from gasoline to diesel engines? Part of the answer lies in the fact that investment cost is roughly four times as high for a diesel engine of a size comparable to the 10- to 16-hp gasoline engines commonly used throughout the Philippines (Holazo 1982). Despite its more economical operating characteristics, a diesel engine costing more than ₱10,000-₱12,000 is probably beyond the financial reach of most small-scale fishermen. Moreover, the narrow *bancas* and mini trawlers are ill-suited to accommodate the heavier, bulkier diesel engines. Other factors favoring the continued use of gasoline engines are that the most commonly used engine (Briggs and Stratton single cylinder) is easily maintained, and the supplier provides mechanics' and maintenance courses and service representatives throughout the country.

From the above, it is clear that the value and distribution of resource rents from the San Miguel Bay fishery depends upon the costs determined for inputs. Cost-benefit studies should make use of shadow ("true opportunity cost") prices in their calculations (Gittinger 1972; Panayotou 1982), but economic analyses of tropical fisheries often seem to have been confined more narrowly to strictly 'financial' analysis, whereby rates of return on investment are reported using market prices without any reference to opportunity costs of labor or capital or to possible subsidies or taxes on inputs such as fuel.

There is considerable debate on these opportunity cost and shadow price concepts among economists and it is especially difficult to establish the "true" opportunity costs of capital and labor, which in some cases may be very low (see Squire and van der Tak (1975) for a discussion of the issues). For example, there are those who will argue that an opportunity cost of labor as used here (₱10-20/day depending upon skill level and location) is too high, given the prevalence of unemployment and disguised unemployment in the Bicol Region (see Castillo (1979) for regional employment and income data). Conversely, the 9% opportunity cost of investment capital selected for this study may be thought by some to be too low, given the alternative investment opportunities outside fishing that are probably available to owners of trawlers. However, for owners of gill-netters who received government loans and who did not repay them, any positive value for opportunity cost of capital (and of depreciation) distorts the analysis as far as private gill-netters are concerned. Certainly there is a social cost involved in providing capital to small-scale fisheries because the government has alternative investment opportunities open to it.

The appropriate labor opportunity cost, or shadow wage rate, depends not only upon the presence of locally available employment options, but also upon the mobility of labor. In the case of San Miguel Bay, there have been significant rates of outmigration from the area in response to the low prevailing wage in Bicol and better opportunities elsewhere, especially Manila. Because of this outmigration, it would be incorrect and potentially very misleading to assign a near-zero opportunity cost to San Miguel Bay fishery labor. There are also more practical reasons for this viewpoint. A shadow wage rate less than ₱10-20 would increase the pure profits accruing to crewmen labor (see Table 5). Given the history of development-oriented approaches in attempting to solve poverty in fishing communities, such a claim of higher pure profits would reinforce tendencies to expand fishing effort within San Miguel Bay which would actually increase poverty. Moreover, establishing a lower opportunity cost for labor could allow planners to rationalize that since pure profits are earned, nothing need to be done to raise incomes of the small-scale fishermen of San Miguel Bay.

Rather, the results show that incomes of crewmen derived from fishing on non-trawl fishing units are roughly comparable to the ₱10 daily wage that prevailed for other laborers' occupations (e.g., carpenter's helper, copra worker, sorter in fish processing establishment). These income data,

and incomes after all are the primary determinant of well-being of fishing households, imply that the mobility of labor is such that the markets for labor in fishing and other rural sectors in Bicol are in rough equilibrium. Consequently, given the stock assessment conclusion that increased catch is not possible from the Bay as a whole, any further technological improvements will most likely depress average catches, increase average costs and hence depress average fishing incomes below the opportunity wage in the short term. In the longer term, equilibrium in the labor markets will again result, but at a lower opportunity cost for labor.

There are other factors at play here, of course, especially population growth rates. The research data indicate that despite outmigration, absolute numbers of fishermen are growing by about 2% annually. Thus, population growth has contributed to increases in effective fishing effort along with the technological improvement of vessels and gears noted earlier.

It must be stressed here that population growth is a less important explanation for increased fishing effort than is technological change. In the face of technological improvements, population control programs alone therefore will have little impact on effective fishing effort. Nevertheless, both factors, coupled with lack of any control over access to the San Miguel Bay fisheries, have produced a situation where fishing incomes are low in absolute terms, though roughly equivalent to the low rural laborer incomes that prevail throughout the Bicol Region.

As will be discussed in the next subsection, when one takes into account income in-kind (fish taken home by the crew and not sold), fishing labor income is probably slightly higher than that of most agricultural workers in the vicinity of San Miguel Bay. It is reasonable to conclude that this in-kind income represents a premium accruing to fishermen to compensate for the higher risk in fishing.

#### SHARING SYSTEMS AND INCOMES OF OWNERS AND CREWMEN

In common with most fisheries around the world, crewmen and owners in San Miguel Bay share the net revenue which represents value of the catch minus certain operating expenses. The division of the net revenue varies depending upon the gear type, whether or not the owner actually goes fishing, the opportunity cost of labor in the area and the extent of non-economic (social and kinship) relationships that may exist between owners and crewmen.

A typical sharing arrangement for a motorized gill-netter is depicted in Fig. 9. The income of the owner varies depending upon whether or not he joins the fishermen; if so, he receives a labor share that would normally accrue to a crewman (or boat pilot). Trawler owners do not go fishing but remain onshore to manage their fishing business and to handle marketing of the catch of their boat(s).

The only gear type for which no sharing system was found was the fish corral. In this case, crewmen received ₱10/day regardless of the total value of the catch. Because this payment to labor approximates labor opportunity cost, owners of this gear have been able to keep the full resource rent (pure profits) earned by their gears rather than pass any of it along to ordinary crewmen as occurs for most other gears. Of course, offsetting this potential disadvantage is the fact that fish corral crewmen also bear less risk than do their counterparts who participate in sharing systems and thus share in losses also.

One factor which appears to have resulted in some shifts in the gill-netter sharing system is the presence in certain areas of increased alternative employment opportunities for labor. The usual sharing arrangement for gill-netters is 50% of net revenue to the owners and 50% divided among the crew. Non-fishing owners sometimes give an incentive payment to pilots from their share. In Sabang, Calabanga where the presence of the trawler fleet has opened up opportunities for labor as trawler crewmen and generated added secondary employment opportunities in fish processing (e.g., drying) and in transportation, gill-net owners now offer their crews a 60% share of net revenue. This type of flexibility in sharing was found to be less prevalent in large-scale trawl fishing units, however, than

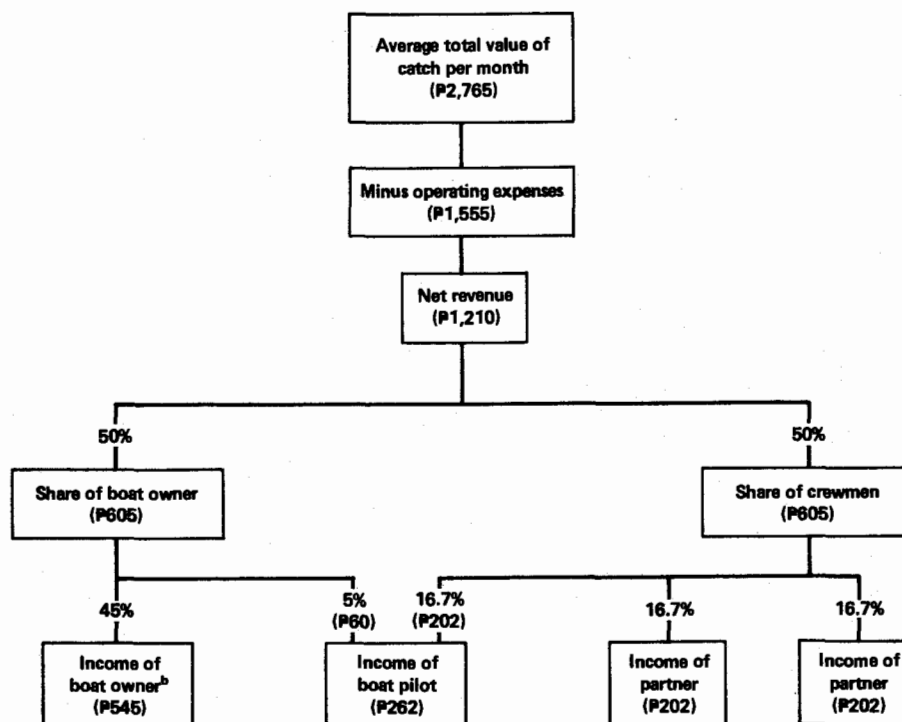

Fig. 9. Typical shering system of Cabusao gill-netters with boat pilot receiving incentive share from boat owner. (Data from 2,106 fishing trips of nine gill-netters in 1980/81).<sup>a</sup>

<sup>a</sup>Note that these costs and incomes are for a gill-netter with crew of three, one of whom was a pilot receiving an incentive share from the non-fishing owner. Not all gill-netter pilots received such an incentive, however (see Table 7 for income of crewmen from all gill-netters in the study sample).

<sup>b</sup>Before deducting fixed and variable costs borne by owner.

in the small-scale units where kinship ties between owners and crew are more common. This separation of ownership from the actual fishing operation is a further category that separates small and medium trawlers from the bulk of the "municipal" small-scale, non-trawl fisheries (see also Smith et al. 1980 and Spoehr 1980).

Because of these variations of sharing systems within and among gear types, owner and crewmen incomes will also vary. Based on daily record-keeping data from 64 fishing units of various types (covering 11,248 fishing trips in all) and using weighted averages of incomes by sharing system for each sampled gear type, average monthly incomes of non-fishing owners, owner-operators, pilots (*maestros*), machinists and ordinary crewmen were calculated (Table 7). The income figures in this table represent cash incomes after deduction of all fixed and variable costs (not including opportunity costs of own capital and labor which were deducted to calculate pure profits or losses). These income figures are those that fishermen would view as their earnings and that economic analysts would compare with opportunity costs to determine the presence or absence of pure profits.

It is immediately apparent that the incomes of owners and crewmen of scissor nets, motorized gill-nets, liftnets and filter nets are considerably lower than those of their counterparts on mini trawlers and small trawlers. Crewmen on fish corrals, as explained earlier, are a special case in that they receive a daily wage, to the apparent benefit of owners. Also, the relatively low incomes for owners and crewmen of medium trawlers are a reflection of the high-fuel expenses of those units. Small trawlers are thus in a different income category from all other gear types in San Miguel Bay.

Also shown in Table 7 are the average numbers of fishing days per month for these gear types. Especially for the small-scale gear types, crewmen are expected by owners to participate in gear

repair on some nonfishing days. The monthly incomes shown represent earnings for all days committed to the fishing unit, both fishing and onshore. Therefore, crewmen incomes per day worked (1980-1981) were as follows:

<i>Small-scale fishery:</i>	
Scissor net (owner-operator)	₱ 9.05
Motorized gill-net	10.50
Stationary liftnet	9.65
Fish corral	8.50
Filter net	9.65
Mini trawler	17.45
<i>Large-scale fishery:</i>	
Small trawler	24.75
Medium trawler	14.00

There are several important points to be made regarding the results above and those in Table 7. First, these incomes do not represent fishing *household* income. Most fishing households have more than one fishermen and some own more than one fishing unit. Concentration of ownership and hence of incomes is particularly characteristic of the small/medium trawler fleet. Second, many non-trawl ordinary crewmen shift from one gear type to another. During the fishing season they have opportunities for increasing their monthly incomes (though not their daily incomes) in this manner. Nevertheless, large numbers of fishermen did not fish continuously throughout the year (Table 8). Third, all crewmen receive some of the catch in-kind for their family's subsistence. Though a valuation of this in-kind income is not included in the above income figures, it is estimated that the daily take-home catch per gill-netter crewman, for example, was approximately 0.7 kg valued at ₱2.20.

Fourth, the daily incomes of crewmen for the non-trawl gears (₱8.50-₱10.50) are slightly higher than the prevailing wage in other occupations when income in-kind is included. This income above the opportunity cost of labor may be thought of as a premium for the added risk and uncertainty in fishing. Interestingly, Librero et al. (1982) have also found fishing incomes in several other locations in the Philippines to be slightly higher than income earned in other rural occupations such as agricultural laborer.

Fifth, the higher crew incomes on small trawlers explain why many non-trawl fishermen aspire to places in the crew of small trawlers. There are limited numbers of these crew positions available, however. The possibility of increased incomes has apparently led some small-scale fishermen to turn over their individual ₱15,000 *Biyayang Dagat* (a currently available government credit program for small-scale fishermen) loans to a guarantor who will then build a small trawler and guarantee them a place in the crew in return.

Finally, and most importantly, the monthly incomes of the majority of fishermen, despite being equal to or slightly higher than the opportunity wage, are still extremely low. Seventy-two percent of respondent fishermen had no other source of supplementary income. In 1980 after compensating for inflation, household incomes (including in-kind earnings) for a rural family of six would have to be at least ₱15,389 annually to exceed the rural poverty threshold established for 1971 (₱5,000) by the Development Academy of the Philippines (Abrera 1976).<sup>\*</sup> Although in this study of San Miguel Bay, fishermen did not estimate household incomes *per se*, it is quite clear that the monthly incomes per fisherman shown in Table 7, coupled with an average household size of 6.8, would leave the vast majority of the 3,500 San Miguel Bay fishing households well below the DAP poverty threshold. Only owners of small trawlers are likely to have incomes exceeding the poverty threshold.

<sup>\*</sup>Rural Consumer Price Index was approximately 90.0 in 1971 (1972 = 100); 167.3 in 1975; and 277.0 by January 1980. (Source: Dept. of Economic Research, Central Bank of the Philippines).

Table 7. Average monthly fishing days and cash incomes in pesos of owners and crewmen in San Miguel Bay, 1980-1981, by gear type after sharing and payment of all fixed and variable costs.

Gear type	No. of months operated	No. of fishing days/month	No. of gear repair days/month	Total no. of days/month	Income of owners <sup>b</sup>		Income of crewmen		
					Non-fishing	Owner-operator <sup>c</sup>	Pilot ( <i>maestro</i> )	Machinist	Ordinary crewman <sup>d</sup>
Scissor net	3	14.7	—	14.7	n/a	133	n/a	n/a	n/a
Gill-net (motorized)	12	18.3	2.5	20.8	271	516	245	n/a	218
Stationary liftnet	4	13.8	3.2	17.0	(773) <sup>e</sup>	(543) <sup>e</sup>	230	n/a	164
Fish corral	7	20.7	3.6	24.3	740	947	n/a	n/a	207
Filter net	12	15.8	2.1	17.9	175	348	n/a	n/a	173 <sup>f</sup>
Mini trawler	12	15.6	4.0	19.6	432	877	445	n/a	342
Small trawler <sup>g</sup>	12	20.8	3.4	24.2	1,693	n/a	810	698	599
Medium trawler	12	20.8	3.4	24.2	146	n/a	482	400	339

n/a: not applicable

<sup>a</sup> Opportunity costs of owners' labor and capital and opportunity costs of crewmen (labor) not yet deducted. Based on average number of months of operation.

<sup>b</sup> After deducting fixed and variable costs that must be borne by owner. This is owner income per fishing unit.

<sup>c</sup> Owner-operator receives owner's share plus one crew share (or pilot's share if applicable).

<sup>d</sup> Ordinary crewmen who own no fishing assets, except in the case of gill-netters where ordinary crewmen may contribute nets.

<sup>e</sup> Loss.

<sup>f</sup> Part-time only.

<sup>g</sup> Weighted average of Sabang and Castillo based trawlers.



Table 8. Number of months fishermen in San Miguel Bay spent fishing in the 12 months from February 1980 to January 1981 (n = 620).

Months of fishing	No. of respondents	Percentage of respondents	Cumulative percentage
12	240	38.7	38.7
11	73	11.8	50.5
10	70	11.3	61.8
9	49	7.9	69.7
8	61	9.8	79.5
7	16	2.6	82.1
6	37	6.0	88.1
5	20	3.2	91.3
4	15	2.4	93.5
3	11	1.8	95.3
2	2	0.3	95.6
1	3	0.5	96.1
0	23	3.7	99.8

Source: Primary data from socioeconomic survey (Bailey 1982a).

Note: Data unavailable on 21 of our 641 respondents. The 23 respondents who reported no fishing in 12 months preceding our survey gave various reasons such as health for their inactivity. Cumulative figures do not total 100% due to rounding.

These results are consistent with the findings of others who have studied income levels in the Bicol (Castillo 1979; Rondinelli 1980; USAID 1980). Indeed, the government's statistics (NEDA 1975) showed 87.3% of Bicol families with incomes below the DAP poverty threshold in 1971; by 1975 this figure had increased to 93.8% after adjusting the poverty threshold for inflation in rural areas (NEDA 1982). In real income terms, the majority of the Bicol households were worse off at the end of the 1970s than they had been at the beginning of the decade. For small-scale fishing households the problem has translated into increasing costs due to inflation, a decline in catch which they attribute primarily to trawlers, and fish prices received at the beach that have not increased as rapidly as costs, especially costs of fuel.

#### MARKETING AND MARKETING ORGANIZATIONS

Improvements in marketing are frequently proposed as one means of raising incomes of fishing households. To assess the potential for this solution, the activities of various categories of middlemen and processors and of women in marketing were examined. As in many other fisheries of the world, women play an essential role in marketing of the catch from San Miguel Bay. Fishermen involved in harvesting generally leave the selling of their catch to their wives or to other female members of their household.

The structure of the marketing sector was influenced by several external factors. The extent of processing (i.e., drying and salting) varies with the seasonal nature of the catch (and the gear shifts that accompany it) and of the weather. Approximately 30% of the Bay's catch was processed. Generally speaking, the more isolated the community, the greater the extent of processing within the community. Communities in the southern part of the Bay and near Mercedes in the northwest were more closely linked by road to urban markets and were more likely to be frequented by larger numbers of buyers, not only making for a more competitive environment in which fishing households disposed of their catch, but also reducing their need to dry much of their catch. Highest rates of dissatisfaction with the existing marketing system were recorded in the more isolated communities such as Siruma on the northeast coast of the Bay.

The majority of fishing households were tied to particular buyers, known locally as *suki*, from whom they obtain credit and sometimes inputs, such as fuel, and to whom they must sell their catch,

often at a 10% discount in price received. Despite this tie, the majority of fishermen-respondents expressed satisfaction with this arrangement.

Another factor which influences the extent of ties between harvesters and middlemen was the type of gear used and the size of the catch. For example, owners of gill-netters and other minor non-trawl gears usually sold their catch to their *suki* or to *rigaton* (middlewomen) who bought directly at the landing. Rarely were fishing households using these gear types involved directly in wholesale or retail marketing. In contrast, there was more vertical integration in markets that handled the catch of trawlers. Owners of small trawlers usually served as their own brokers and in some cases as processors of their own and others' catch. The same was true for many of the owners of mini trawlers, which in fact could largely be classified as processors first and owners of mini trawlers second.

In the more remote communities, processing was often a household activity with women playing a prominent role; in communities such as Castillo, Cabusao and Sabang, Calabanga a few large processors dominated the market; their daily incomes were much higher as a result. The majority of small-scale processors and fresh and dried fish dealers, however, earned daily incomes (P10-35) that were only slightly higher than the incomes of the better-off fishermen. Economies of scale in processing and marketing were found to be distinctly limited, and most middlewomen who sold fresh and dried fish seemed to have adopted attitudes of live-and-let-live *vis a vis* their competitors, an attitude regarding competition reminiscent of that found in other Philippine markets (Szanton 1972). Consequently, given present conditions, it is difficult to markedly improve the marketing sector to the benefit of small-scale fishing households, although some potential exists for cooperative processing activities. Entry barriers here are high, however, because processors are a major source of credit to fishermen.

In light of the limited success with fishing cooperatives in Bicol and elsewhere in the country, it is concluded that a single-function cooperative or association is unlikely to succeed. Preferable would be groupings that engage in gasoline supply, processing and marketing such as in Mercedes (Toh 1980). These groupings should consist of women, not of men whose current function in fisheries is limited primarily to harvesting. Finally, as presented in the next section on management options, there may be a very useful function for groupings in fishing communities to perform in terms of fisheries management.

#### MIGRATION PATTERNS AND ALTERNATIVE SOURCES OF INCOME

Dependency upon fishing varies from one community to another around San Miguel Bay, but in general there are only limited local alternatives for generating supplementary household income. The most attractive means of increasing income, especially for young people, has been to migrate out of the Bicol Region altogether (Kim 1972; Ilo and Lynch 1974a, 1974b; Cariño 1979; Roco 1980).

In an earlier study that covered the whole of Bicol, Piansay et al. (1979) found that 88% of fishing households had no income source other than those that were fishery-related, such as harvesting, processing and marketing. The earlier results are consistent with the results of this study which also showed a heavy dependence upon fishing for San Miguel Bay households (Table 9). The most important means of supplementing fishing income was through agriculture; but most fishing households faced a severe constraint in this regard due to their lack of access to land. Less than 10% of 641 fishing household respondents in the present study had regular access to farm land while only 1% owned rice or coconut land, the two most common forms of productive land in the vicinity of San Miguel Bay fishing communities.

The potential for local agriculture to absorb surplus fishing labor was assessed; there are distinctly limited possibilities. For example, the very small size of rice land holdings in the area, which

Table 9. Prevalence of supplemental occupations among respondent fishermen in San Miguel Bay.

Type of supplemental employment	No.	Percentage
No supplemental occupations	459	71.6
Farming	83	12.9
Planting of root crops, maize, etc. for home consumption only	26	4.1
Laborer (including agricultural or other temporary laborer)	25	3.9
Petty trading (including fish and other products)	19	3.0
Carpentry	9	1.4
Animal husbandry	5	0.7
Others	15	2.3
Total	641	99.9

Source: Primary data from socioeconomic survey (Bailey 1982a).

Note: Total percentage does not equal 100 due to rounding.

averaged 2.52 ha in Camarines Sur and 3.39 ha in Camarines Norte in 1971 (NCSO 1971a, 1971b), implies that most rice land is farmed by owners and does not require large amounts of hired labor. Land reform activities in the area have concentrated upon tenant rice farmers to the exclusion of landless laborers and fishermen. Under land reform in coastal barrios of Cabusao and Calabanga, Certificates of Land Transfer involved only 165 tenants and the average size of plots awarded was only 0.88 ha (Ministry of Agrarian Reform, Magarao Office, Camarines Sur). Consequently, fishing households are unlikely to benefit directly from redistribution of rice lands, though they may benefit indirectly from road and other infrastructure improvements that accompany the development of irrigation networks in the rice land areas to the south of the Bay.

An assessment was made of other employment opportunities in lowland and upland activities—agriculture, aquaculture, cottage industries and agroindustries—such as preparation of commercial feeds for livestock—and small-scale animal husbandry. It was concluded that only the last two of these offered much hope for absorbing rural labor from other sectors or supplementing fishing household incomes. In particular, pig-raising using mixed or local breeds, which is already practiced by over 40% of fishing households, seemed well-suited to add small amounts to family incomes. However, even these more promising alternatives hold little prospect for attracting large numbers of fishermen, so as to result in a reduction of effective fishing effort.

As long as industrial development in the Philippines is centered in and around Metro Manila, the marginalization of rural areas such as Bicol can be expected to continue. The response of Bicol residents to continuing lack of local opportunities is most evident in migration patterns. The Bicol Region has historically had one of the highest rates of outmigration in the Philippines and this can be expected to continue (Drew et al. 1975). Contrary to views commonly held elsewhere in the world that fishermen are immobile (Gordon 1954), Filipino fishermen have often expressed willingness to change occupations and locations (results of numerous studies are summarized in Smith et al. 1980). Interviews of fishing households in San Miguel Bay in the present study produced similar results. High degrees of stated willingness to change both occupation and residence were found among fishermen regardless of age, educational attainment, ownership of house or land, and type of fisherman (e.g., owner-operator, crewman). For example, 44% were willing to change occupation even if it required a move to a different municipality. An overwhelming majority (83%) of respondents would encourage their children to leave their home community if an occupation elsewhere

provided higher income and standard of living. This stated willingness to change occupations and residence is consistent with actual migration patterns over the past 30 years.

Nevertheless, due to natural population increase offsetting outmigration which resulted in a 2% annual rate of increase (Table 10), it is estimated from the present study that numbers of fishermen increased from 3,200 in 1948 to 5,600 in 1980, adding to the increases in effective fishing effort caused by introduction of synthetic netting and particularly motorization.

Table 10. Populations of the fishing barrios of the coastal municipalities of San Miguel Bay, 1939-1980.

Municipality	Year						Average annual rate of increase 1939-1980
	1939	1948	1960	1970	1975	1980	
Cabusao	3,529	4,291	5,700	6,301	6,931	7,430	1.83
Calabanga	2,452	3,856	6,454	6,095	6,737	7,716	2.84
Mercedes	3,102	2,864	4,998	6,333	8,144	8,619	2.52
Sipocot	1,375	3,102	2,685	3,397	3,727	4,060	2.68
Siruma	1,752	1,523	1,671	1,925	2,389	2,812	1.16
Tinambac	5,057	7,049	7,273	8,297	7,736	8,879	1.38
Total	17,267	22,685	28,781	32,348	35,664	39,516	
Annual rate of increase	—	3.08	2.00	1.18	1.97	2.07	2.04

Source: Bureau of Census and Statistics (1939, 1948, 1960); NCSO (1970a, 1970b, 1975a, 1975b, 1981).

### FISHERMEN'S VIEWPOINT

In addition to gathering data from respondents regarding occupational and geographic mobility, researchers obtained data regarding fishermen's perceptions of the San Miguel Bay fisheries. The single most important issue of concern for the fishermen-respondents (n = 641) was the alleged recent decline in their catch. Of the 79% who claimed lower catch, fully 75% blamed various forms of increases in effective fishing effort. Examples in the words of the fishermen themselves were: "destructive trawlers (fine meshed nets);" "increased number of fishermen;" "depletion of the Bay;" and the "use of more improved gear by other fishermen." Respondents were particularly outspoken regarding the illegal operation of trawlers in depths less than 4 fm (7.3 m).

The solutions offered by these fishermen to the above problem epitomize the basic conflict between individual solutions and those that would benefit fishermen as a group. Almost without exception the suggested solution to declining catch was to improve one's own vessel and gear so as to compete better with other fishermen, including trawler operators. Only secondarily mentioned was the need to effectively enforce existing regulations that delimit areas of operation for trawlers.

### CONCLUSIONS

The results of this multidisciplinary analysis of the small-scale fisheries of San Miguel Bay, taken together (Tables 11 and 12) not only illustrate the dichotomy between the large-scale and small-scale fisheries but also imply that:

- Improvements in technology will not increase total catch, but rather will increase costs, further reduce pure profits (resource rents) and in the long run reduce incomes of the majority of small-scale fishermen.
- Technical improvements cannot adequately address the inequitable distribution of benefits that presently exists between the small-scale and the large-scale fisheries.

Table 11. Summary of data on the San Miguel Bay fisheries, 1980-1981.

Characteristics	Small-scale fishery		Large-scale fishery	Totals for the San Miguel Bay fisheries (all fishing units)
	Non-trawl gears	Mini trawlers	Small/medium trawlers	
No. of fishing units	2,100	188	95	2,382
Total horsepower	2,592	3,008	13,200	18,800
No. of fishermen	4,625	376	600	5,600 in 3,500 households
No. of households owning fishing units	≈ 1,800	≈ 150	35	2,065
Average investment cost per fishing unit (₱)	250–13,000	9,200	55–70,000	₱15.5 million current replacement cost
Percent of total catch (19,133 t)	44	25	31	
Percent of total value (₱53.5 million)	44	14	42	
Percent of pure profits (resource rents) <sup>a</sup> (₱3 million)	15 <sup>b</sup>	35	50 <sup>c</sup>	
Crewmen cash incomes/mo (₱)	164–218	342	339–810 <sup>d</sup>	
Owner cash (non-fishing) incomes/mo (₱)	(-773) <sup>e</sup> –740	432	146 <sup>f</sup> –1,693	

<sup>a</sup>Does not include resource rents earned by the government and by fuel suppliers/processors.

<sup>b</sup>One-half of this is earned by fish corrals; 40% by motorized gill-netters.

<sup>c</sup>Small trawlers only; medium trawlers did not cover their opportunity costs.

<sup>d</sup>Highest incomes are earned by pilots on small trawlers.

<sup>e</sup>Owners of stationary liftnets incurred losses.

<sup>f</sup>Lowest incomes are earned by owners of medium trawlers.

- Effective fishing effort is likely to increase further through added investment and population growth unless steps are taken to limit effort in some way.
- Increases in effective fishing effort are most likely to come in the form of additional small trawlers (because of their lower fuel tax payments than those using gasoline engines) which will further skew the distribution of catch, catch value and incomes in their favor, to the detriment of the majority of the Bay's fishermen.
- Improvements in marketing or even increased roles for fishing households in processing and marketing are likely to add only minimally to incomes of the majority of fishing households, though some possibilities may exist for group processing activities.
- Locally available income-generating activities other than fishing are neither available in sufficient numbers nor with high enough income to provide significant employment for the steadily growing population in coastal communities of the Bay.

All perspectives of the San Miguel Bay fisheries, including those of fishermen themselves, point to the same conclusion; that is, the twin problems of overfishing and inequitable distribution of benefits can only be overcome if steps be taken to limit effective fishing effort by *managing* the Bay's fisheries. Reductions in effective fishing effort in the Bay can also be expected to lead to reductions in costs and hence increases in the resource rents of this fishery.

Table 12. Summary of results of the multidisciplinary investigation of the San Miguel Bay fisheries.

Stock assessment		Economics		Sociology/mobility	
Ecosystem description	Ecology of fishes described. Silt deposition of 2.5 cm/yr estimated	Costs and earnings	Reported for each major gear type, investment costs, costs and earnings, determinants of catch, and returns to owners and crew according to various sharing system practiced. Showed that for some gears (esp. small trawlers), owners and crew earn significantly more than their opportunity costs, while most non-trawl fishermen do not.	Ownership patterns and sharing system	Little concentration of ownership for non-trawl gears, highly concentrated for trawlers. Kinship important for non-trawl gears; less so for trawlers. Diverse sharing systems determined by kinship and alternative income opportunities.
Catch	Annual catch (1980-81) estimated to be 19,000 t, including sergestid shrimp. From species composition by gear type, extent of competition among gear types established.	Total costs and value of catch	Total annual value of catch (1980-81) estimated to be approximately ₱53 million; total costs to be approximately ₱50 million (valuing fuel at its market price). Distribution of value among competing gear types established.	Role of women	Women control family finances and have important role in fishing investment decisions; women dominate marketing system.
Fishing effort	Horsepower in fisheries increased from 1,500 hp (1971) to 18,800 hp (1980).	Fishing incomes	For non-trawl fishery, crewmen incomes range from ₱164-218 monthly; ₱339-599 monthly for trawler crewmen. Only small trawler owners earn enough to place them above poverty threshold.	Fishermen's perceptions of resource	Three-quarters believe average catch declining: 1/3 blame trawlers; 1/4 blame increase in all categories of fishermen; 1/4 don't know reason.
Trawlable biomass	Estimated using surplus yield models to have declined from 8,900 t (1947) to 1,650 t (1980) indicating overexploitation.	Resource rents (pure profits) in the fishery	Share of resource rents being earned by each major gear type was estimated. Concentration of current resource rents in the hands of a small number of trawlers was demonstrated. Most of the small-scale non-trawl gears were earning little or no resource rents; therefore there was a very skewed distribution of benefits from the fishery. The government earned a major share of the rents through its tax on fuel. Processors/fuel suppliers earned a small share through oligopsony/oligopoly power and lower prices paid for catch.	Marketing system	Important socioeconomic role of "suki" system of favored buyer, seller and mutual help implied.
Yield per area	22.8 t/km <sup>2</sup> including sergestid shrimp. Used to suggest that increased effort will not increase catch.	Extent of over-fishing	Increases in effort will add to costs, further dissipate remaining resource rents and reduce incomes for majority of fishermen.	Occupational and geographic mobility	Forty-five percent of respondents willing to move to different municipality to take up different occupation, 39% willing to move to different province, willingness cuts across all groups by age, education and asset ownership, 88% want their children out of fishing.
Extent of overfishing	Available evidence suggests that the Bay is overfished in the sense that an increase in effort by either the trawl or non-trawl fishery would not result in increased catch, but rather exacerbate the present allocation problems between the trawl and non-trawl fisheries.	Performance and economies of scale in wholesale market	No significant economies of scale found for processors. In target communities, a small number of processors control the bulk of the volume handled, and entry barriers are high.	Migration	Significant outmigration but insufficient to reduce numbers of fishermen. Females more likely to migrate out than males.
		Performance and economies of scale in retail market	No significant economies of scale or entry barriers in fresh or dried fish marketing from target communities. Large number of middlewomen earn only slightly more per day than the fishermen from whom they buy.	Alternative occupations	Prospects of full-time local alternatives very dim; some hope of supplementary income through small-scale animal husbandry and commercial-agriculture.
				Implications for raising incomes	Short-term solution requires re-allocation of benefits from fishery, long-term solutions must be sought outside fishery.

### 3. Present Management of San Miguel Bay Fisheries

#### HISTORICAL BACKGROUND

Calls to manage Philippine fisheries were first made almost 50 years ago, but progress towards management has been slow. Umali (1932), for example, after discussing the activities of 70 Japanese trawlers throughout the Philippines stated:

Depletion which may come about in the future as the natural outcome of the continuous and unregulated activity of beam trawlers may be prevented by the Government exercising complete control of this method of fishing, and guarding against overactivity in order to insure and conserve the richness of our seas.

By 1937, Umali reported the spread of these trawlers from Manila Bay to San Miguel Bay. His research (1937) was apparently conducted in response to petitions forwarded by fish corral owners to national authorities in opposition to these Japanese-owned beam trawlers. He concluded:

beam trawling operations in San Miguel Bay need to be regulated . . . such regulatory measures must be based on results of scientific investigation . . .

Umali went on to comment on the need for "coordination of the different local regulations relating to fisheries . . . to avoid conflicts between the commercial . . . and municipal operators and among the local fishers themselves."

The Second World War intervened and Japanese trawling in San Miguel Bay was curtailed. Trawling activity resumed again after the war on a limited scale. Warfel and Manacop (1950) were the next group of researchers to comment on the Bay, observing that

This is the only ground in the Philippines where trawling is regulated through the Philippine Bureau of Fisheries. It is closed to dragging from June 1 to October 31 each year, during which period fishing with other gear is allowed.

and

Four or five trawlers probably could be maintained without endangering the resources. The closed season now in effect, although unproven as an effective conservation measure, seems to afford the beginning of a proper system of management. The conflict between native fishing gear interests and power-operated boats is minimized by the closed season.

For the next thirty years until this present study, occasional exploratory fishing expeditions and biological studies were conducted in the Bay but no further advice was offered regarding the need for management of the Bay's fisheries except for one recommendation of Legasto et al. (1975) who, remarkably, advocated closing the whole Bay to all types of fishing for a period of five years! What the many thousands of fishermen of the Bay were to do in the interim was not disclosed.

#### CURRENT STATUS OF THE FISHERY

The closed season for trawlers mentioned by Warfel and Manacop (1950) was no longer in effect by 1980 and it could not be determined whether it was ever enforced or how and when it lapsed. A mix of municipal and BFAR regulations then prevailed; these appear to provide an unnecessarily complex and cumbersome framework for the management of the Bay. Rather than rational management, by 1980 the Bay was characterized by essentially open-access conditions and appeared in danger of typifying Hardin's (1968) "tragedy of the commons," with overcapitalization and dissipation of all positive resource rents with increases in fishing costs. By the late 1970s, Simpson (1978) claimed that the Bay was overfished. Small and medium trawlers had rapidly expanded in both numbers and horsepower during the 1970s and a significant portion of the gill-net fleet had become motorized. By 1981, total horsepower in the small-scale and large-scale fleets was 18,800 hp.

The resiliency of the stocks and the continued high prices of the penaeid shrimps that have come to be the most valuable component of the catch are two reasons continued exploitation at these high levels of effort remains possible. The level of resource rents found in 1980-81 (P3 million accruing to fishermen, mostly trawlers; P2 million to fuel suppliers and processors; and P5 million

to the government in the form of fuel taxes) was still positive, implying that equilibrium has not yet been reached. The rents accruing to fuel suppliers/processors and the government through fuel taxes inhibit further expansion in levels of effort of the small-scale non-trawl fleet. However, the rent earned by the small trawlers and the mini trawlers represents an opportunity for new entrants.

The rationale for improved management of the Bay's fisheries stems from the conclusions drawn by scientists working in the three disciplines (stock assessment, economics, sociology) which are briefly summarized below. Relevant catch and effort statistics are shown in Table 13.

Table 13. Summary of major catch and effort statistics<sup>1</sup> of the San Miguel Bay fisheries, 1980-1981.

Annual catch	19,000 t including 4,800 t of sergestid shrimp. Total annual catch probably levelling off.
Catch composition	Increased proportion of small fast-growing short-lived species.
Trawlable biomass	1,650 t in 1980, down from 8,900 t in 1947.
Total no. of fishing units	2,382: of which 95 are small and medium trawlers; 188 are mini trawlers catching sergestid shrimp.
Total no. of fishermen	5,600, increasing 2% annually.
Total horsepower	18,800 hp up from 2,100 hp in 1971.
Catch per unit effort	Declining.

<sup>1</sup> These results, which show dramatic increases in effort and declining trawlable biomass, are consistent with a levelling off (not yet declining) catch. The continued high catch from the Bay is possibly due to the fact that the large slow-growing long-lived species have been replaced by small fast-growing short-lived species.

The stock assessment work, using both total biomass and single-species based methods led to the conclusion that further increases of effort will not increase catches. If, as appears likely, effort increases in the form of additional large-scale trawlers, there will be a further transfer of catch away from the small-scale non-trawl fishery to the large-scale fishery.

The economic analysis confirmed this competition between the small-scale and large-scale fisheries. The two fisheries combined produced a catch worth approximately ₱53 million per annum (based on prices received by fishermen) and a resource rent for the fishermen of ₱3 million in 1980-81. Unless entry is limited, expected additions to the large-scale fleet will probably completely dissipate this rent in the next few years. Moreover, the present resource rent earned by fishermen is distributed very unevenly, with the small and mini trawlers (263 fishing units) earning 85%, while the small-scale fishery (2,099 fishing units) earns the balance. Data on concentration of fishing-asset ownership provided by the project sociologists confirmed the highly skewed distribution of benefits from the fishery.

The sociological analysis, particularly studies on the occupational and geographical mobility of the San Miguel Bay fishermen, added another dimension to these results by showing that employment opportunities outside the fishing sector are rather poor and that there is a high rate of migration out of fishing communities. This migration, however, is more than offset by population growth so the absolute number of small-scale fishermen continues to increase. The Bay can be characterized as having a growing number of fishermen but finite fish resources.

Thus, biological, economic and sociological perspectives all gave the San Miguel Bay fishery the same diagnosis: effective management is needed to contain fishing effort and address allocation issues.



## JURISDICTION OVER SAN MIGUEL BAY FISHERIES

The Bay is bordered by six municipalities in two different provinces. These are Mercedes in Camarines Norte and Sipocot, Cabusao, Calabanga, Tinambac and Siruma in Camarines Sur (Fig. 1, p. 3). There are 46 fishing villages around the Bay. Inland from the Bay's western shoreline is the Bicol National Park which is under the jurisdiction of the Bureau of Forest Development, Ministry of Natural Resources. The Park does not border on the Bay.

Municipal authority over waters to three nautical miles (5.5 km) offshore was established by Commonwealth Act No. 4003 in 1932. Under Presidential Decree No. 704 (dated 1975) jurisdiction over the waters of San Miguel Bay is divided between the municipalities and the Bureau of Fisheries and Aquatic Resources (BFAR). The relevant sections are shown below; important points have been highlighted.

**Sec. 3(p). *Municipal waters*** – include not only streams, lakes and tidal waters included within the municipality, not being the subject of private ownership, and not comprised within national parks, public forests, timber lands, forest reserves, or fishery reserves, but also **marine waters included between two lines drawn perpendicular to the general coastline from points where the boundary lines of the municipality touch the sea at low tide and a third line parallel with the general coastline and three nautical miles from such coastline.** Where two municipalities are so situated on the opposite shores that there is less than six nautical miles of marine waters between them, the third line shall be a line equidistant from the opposite shores of the respective municipalities. Disputes regarding jurisdiction over freshwater lakes not included within the limits of a municipality of freshwater or tidal streams forming boundaries between municipalities, shall be referred by the councils of the municipalities concerned to the provincial board.

**Sec. 4. *Jurisdiction of the Bureau.*** – The Bureau shall have jurisdiction and responsibility in the management, conservation, development, protection, utilization and disposition of all fishery and aquatic resources of the country **except municipal waters** which shall be under the municipal or city government concerned: *Provided*, that fish pens and seaweed culture in municipal centers shall be under the jurisdiction of the Bureau: *Provided, Further*, that all municipal or city ordinances and resolutions affecting fishing and fisheries and any disposition thereunder shall be submitted to the Secretary (now Minister) of Natural Resources for appropriate action and shall have full force and effect only upon his approval. The Bureau shall also have the authority to regulate and supervise the production, capture and gathering of fish and fishery/aquatic products.

The Minister of Natural Resources (MNR) and provincial boards also have a role to play regarding approval of municipal ordinances and resolutions and arbitration of any disputes about municipal jurisdiction, respectively.

The 3-nautical-mile (5.5 km) boundary to municipal waters results in the greater part of the Bay coming under municipal jurisdiction, albeit of six different municipalities, while the central 40% (approximately) of the Bay comes under the jurisdiction of the BFAR (Fig. 10).

Municipalities have authority to license all vessels that are 3 GT or under. According to PD 704, Section 3(0); the exact definition is:

***Municipal and/or small-scale fishing*** – Fishing utilizing fishing boats of three gross tons or less, or using gear not requiring the use of boats.

All vessels over 3 GT, regardless of gear type, fall into the category of 'commercial fishing' and are licensed by the Bureau of Fisheries and Aquatic Resources. The granting of fishing privileges by municipalities requires approval of the municipal ordinance by the Minister of Natural Resources (PD 704, Section 29):

***Grant of Fishery Privileges.*** – A municipal or city council conformably with an ordinance duly approved by the Secretary pursuant to Section 4 hereof, may:

- a) grant to the highest qualified bidder the exclusive privilege of constructing and operating fish corrals, oyster culture beds, or of gathering "bangus" fry, or the fry of other species, in municipal waters for a period not exceeding five (5) years: *Provided*, that in the zoning and classification of municipal waters for purposes of awarding, through public bidding, areas for the construction or

operation of fish corrals, oyster culture beds or the gathering of fry, the municipal or city council\* shall set aside not more than one-fifth (1/5) of the area embarked for the gathering of fry, as may be designated by the Bureau, as government "bangus" fry reservation: *Provided, Further*, that no fish corral shall be constructed within two hundred (200) meters of another fish corral in marine fisheries, or one hundred (100) meters in fresh water fisheries, unless they belong to the same licensee, but in no case shall the distance be less than sixty (60) meters, except in waters less than two (2) meters deep at low tide, or unless previously approved by the Secretary

- b) authorize the issuance to qualified persons of license for the operation of fishing boats three (3) gross tons or less, or for the privilege of fishing in municipal waters, with nets, traps or other fishing gears: *Provided*, that it shall be beyond the power of the municipal or city council to impose a license for the privilege of gathering marine molluscs or the shells thereof for pearling boats and pearl divers, or for prospecting, collecting or gathering sponges or other aquatic products, or for the culture of fishery/aquatic products: *Provided, Further*, that a licensee under this paragraph shall not operate within two hundred (200) meters of any fish corral licensed by the municipality, except when the licensee is the owner or operator of the fish corral but in no case within sixty (60) meters of said corral. The municipality or city council shall furnish the Bureau, for statistical purposes, such information and data on fishery matters, as are reflected in such forms.

In addition to the above restrictions on the placement of fish corrals, which in San Miguel Bay are to some extent regulated/licensed by *amonojadores* (Supanga and Smith 1982), two other areas of regulation that are important background for a discussion of fisheries management options for the Bay are (1) those pertaining to depth zones and (2) those regulating the use of trawlers. These two sets of regulations are interrelated, especially as they affect the operation of the so-called "baby" trawlers (renamed small and medium trawlers in reports of this project). The San Miguel Bay example, however, points out several discrepancies in these regulations that apparently leave unanswered questions concerning operation of trawlers.

First of all, Presidential Decree 1015, Section 2 amended Section 35 of PD 704 to read as follows:

*Sec. 35. Trawl fishing in waters seven (7) fathoms deep or less.* — Subject to the provisions of Section 17 hereof, no person shall operate trawls in water seven (7) fathoms deep or less; *Provided*, that baby trawls using fishing boats of three (3) gross tons or less may operate in areas four (4) fathoms deep or more if authorized by existing municipal ordinances duly approved by the Secretary now Minister. *Provided, Further*, that the President of the Philippines may, upon the recommendation of the Secretary now Minister ban the operation of trawls in waters within a distance of seven (7) kilometers (3.78 nautical miles) from the shoreline if public interest so requires.

Various petitions regarding illegal operations of commercial trawlers in San Miguel Bay have been sent by municipal fishermen to national authorities since the early 1970s. The most recent was sent in late 1981. Subsequent to this most recent petition, commercial fishing (vessels > 3 GT) was banned for five years from San Miguel Bay by Fisheries Administrative Order (FAO) No. 136 effective March 1982 (see Appendix A). In September 1982, the President issued Letter of Instruction (LOI) 1269 banning commercial trawling and purse seining from waters within 7 km of the coast of all Bicol provinces (see Fig. 10). This ban was later extended by the May 1983 proclamation of President Marcos which banned indefinitely all commercial trawl and purse seine fishing from waters within 7 km of the coastline of the entire Philippine archipelago. As of December 1983, the national parliament had not taken the necessary action to approve this proclamation. In any case, fishing by large and medium trawlers is now effectively banned from the San Miguel Bay and its immediate environs. FAO No. 136 also defined the waters of San Miguel Bay as those south of a line drawn from Culasi Point in the west to Siruma Island in the east.

FAO No. 136 and the more recent Presidential proclamation, however, do not affect small and mini trawls. In accordance with PD 704 Sec. 35 (as amended and as cited above) municipalities may

---

\* (Now *Sangguniang Bayan/Panglunsod*).

permit trawling by vessels less than 3 GT between the 4-fm and 7-fm marks. Such permission must be granted by municipal ordinance approved by the Minister of Natural Resources; if no ordinance is passed these trawlers must stay beyond the 7-fm mark.

There are two factors here, however, that complicate interpretation of this municipal authority. The available nautical charts for San Miguel Bay were last updated in 1976, but the soundings data for the Bay proper on these charts are the same as those on the 1907 edition of the nautical charts. The updated charts are thus clearly inaccurate, because since 1907 silt from the Bicol River and other smaller streams that empty into the Bay has been deposited at the rate of approximately 2.5 cm/year (Mines et al. 1982). In the 75 years since the Bay's depths were last measured, about 2 m of silt has accumulated on the bottom. Consequently, the 4-fm and 7-fm lines as shown on the available charts no longer apply. The new lines should be drawn at approximately 1-fm deeper depths on the old chart instead (Fig. 10). The portion of the Bay deeper than 4 fm has been reduced from 60% of the surface to 45% and the area deeper than 7 fm from 20% to 15% (Fig. 11). The areas in which small trawlers can legally operate has thus been much reduced, the exact area depending upon the status of municipal ordinances regarding trawling in the 4 to 7-fm depths.

The situation is further complicated by the fact that the shallowness of the Bay in some areas puts both the 4-fm and 7-fm depths beyond municipal waters and within waters under the jurisdiction of BFAR (Fig. 12). According to the letter of the law, BFAR has no authority to allow trawling in waters less than 7 fm. Consequently, it is this study's interpretation of the existing regulations that trawling of all kinds is totally banned from the municipal waters of Sipocot, Cabusao, Calabanga and Tinambac, but is permissible in the waters of Siruma and Mercedes beyond 7 fm.

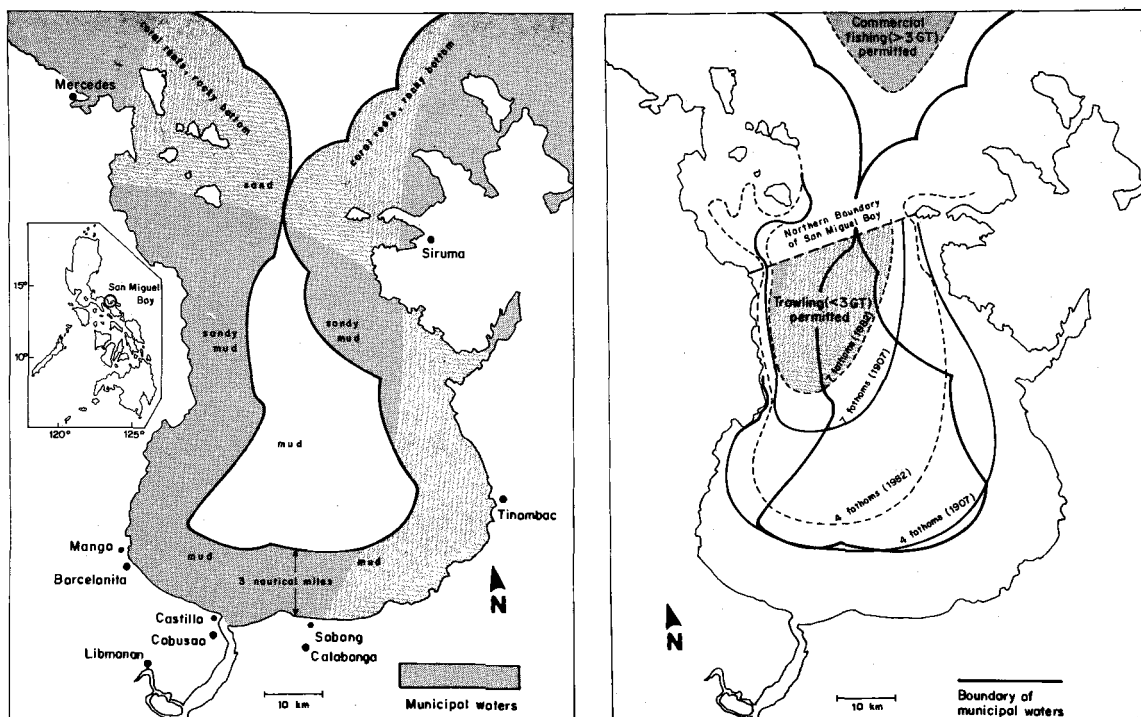

Fig. 10. *Left:* San Miguel Bay showing bottom features and major towns. Municipal waters are shaded. Central portion of the Bay is under jurisdiction of national fisheries authorities. *Right:* Delineation of areas where trawling is permitted is complicated by the gradual shallowing of the Bay which puts most of the trawling grounds outside the municipal waters.

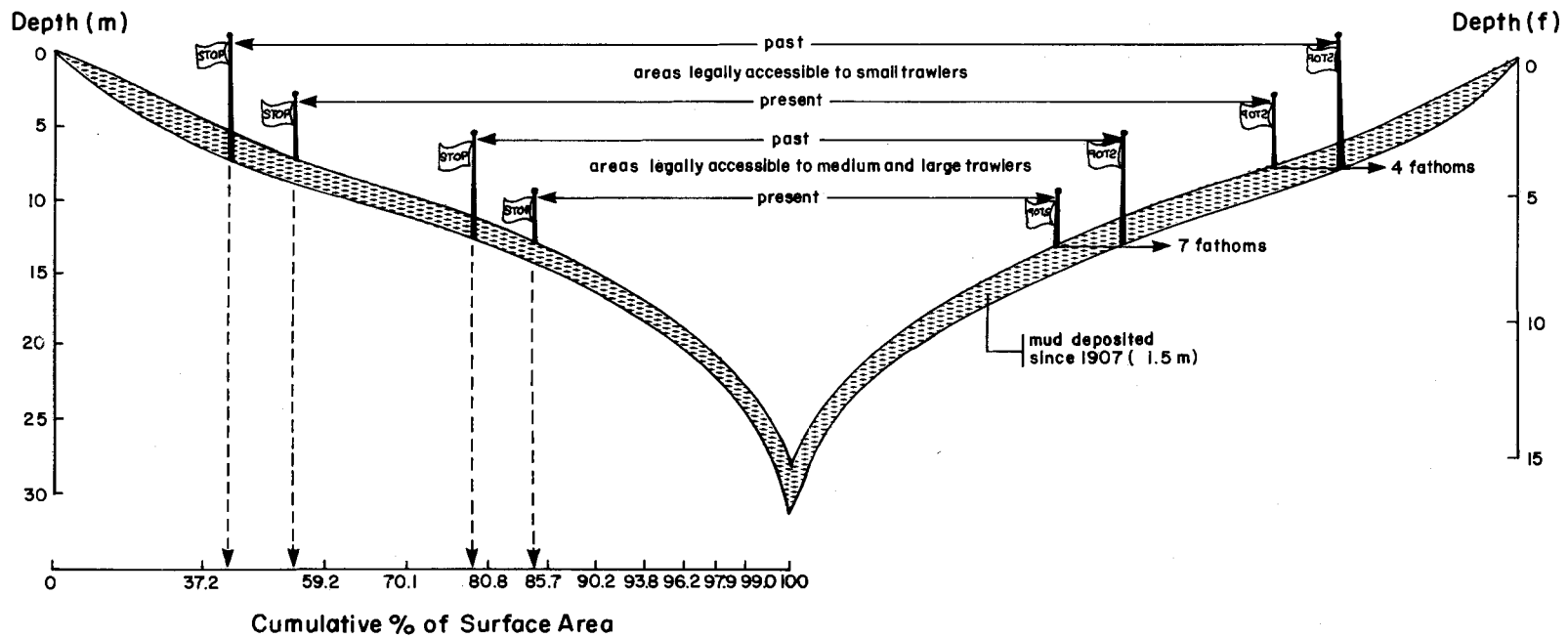

Fig. 11. Schematic representation of the surface area of San Miguel Bay legally accessible to trawlers below 3 GT (small trawlers) and above 3 GT (medium and large trawlers). Note impact of siltation which reduces the area legally accessible to trawlers of all kinds. The 4-fm limit only applies if the respective municipality has passed the appropriate ordinance. See p. 34.

As cited earlier, municipalities must pass ordinances to license fishing vessels (PD 704 Sec. 29) and to permit trawling by vessels < 3 GT in waters between the 4 and 7-fm depths (PD 704 Sec. 35 as amended by PD 1015, Sec. 2). In both cases, before becoming law, the ordinances must be approved by the Minister of Natural Resources.

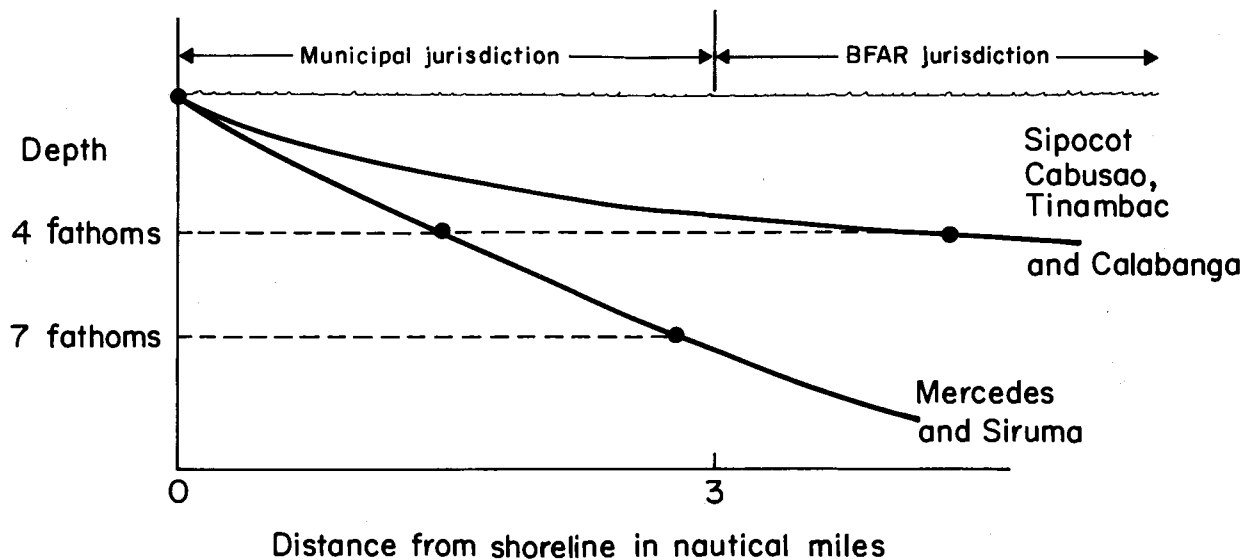

Fig. 12. Depth contours in relation to distance from the shoreline for San Miguel Bay municipalities, based upon 1907 soundings updated to account for siltation.

Director Felix Gonzales of BFAR has kindly provided details on the current status of municipal ordinances from the six San Miguel Bay municipalities (pers. comm., 23 February 1983). This information is summarized in Table 14. It can be seen that only Calabanga and Tinambac municipalities have passed the necessary ordinances to permit trawling in their municipal waters between 4 and 7 fm. However, since the 4-fm mark in the vicinity of these two municipalities is now *beyond* their municipal boundary, these two ordinances have lost their meaning. Even the 1907 4-fm line is beyond the municipal waters of Calabanga though Tinambac would have a small area of its waters deeper than 4 fm based on the outdated charts. Neither of the two municipalities (Mercedes and Siruma) with 4-fm to 7-fm depths in their municipal waters have passed the necessary ordinances to permit trawling there.

Consequently, under the current mix of national legislation and municipal ordinances prevailing in San Miguel Bay, trawling by vessels smaller than 3 GT can be conducted legally only in waters deeper than 7 fm. This conclusion is highly significant because it means that contrary to their current areas of operation small trawlers *must* confine their operations to the middle deeper portions representing only 15% of the total surface area of the Bay (see Figs. 10 and 11). According to the letter of the law, mini trawlers are also restricted to these waters deeper than 7 fm, depths where successful operation would be impossible.

Table 14. Summary of municipal ordinances<sup>1</sup> and water depth information by municipality in San Miguel Bay (1982).

Municipality	4-fm boundary is within municipal waters <sup>2</sup>	7-fm boundary is within municipal waters <sup>2</sup>	Basic fishery ordinance has been passed	Trawl gears are specifically included in basic fishery ordinance	Fishery ordinance has been passed permitting trawling in the 4-7 fm depths
Mercedes, Camarines Norte	yes	yes	yes	yes (P50 annual license fee)	no
Sipocot, Camarines Sur	no	no	no	—	no
Cabusao, Camarines Sur	no	no	yes	no	no
Calabanga, Camarines Sur	no	no	yes	yes (P45 annual license fee)	yes
Tinambac, Camarines Sur	no	no	yes	yes (P45 annual license fee)	yes
Siruma, Camarines Sur	yes	yes	yes	no	no

<sup>1</sup>Based on information received 23 February 1983 from the Bureau of Fisheries and Aquatic Resources (Director F. Gonzales, pers. comm.).

<sup>2</sup>Based on estimates of depth from Mines et al. (1982) which reduce by approximately 1 fm the depths indicated in the 1907 Coast and Geodetic Survey chart of San Miguel Bay (see Fig. 10, p. 32).

The above review of existing legislation and ordinances indicates their inadequacy to deal with the special circumstances of shallow bays and estuaries such as San Miguel Bay. Not only are small-scale specialty gears such as mini trawlers legally banned from the only areas where their fishing methods can be applied, but also small trawlers are legally unable to operate within the waters of the very municipalities that must license them. If nothing else, these points imply that the present 'municipal' and 'commercial' distinctions are inadequate to deal with the case of trawlers less than 3 GT.

These legal distinctions aside, it remains true that mini, small and medium trawlers operated throughout the Bay during 1980 and 1981. Small and medium trawlers were observed trawling within 0.5 km of the shore, especially in the shallow waters of Cabusao, Calabanga and Tinambac where shrimp are found in large quantities. PD 704 authorizes personnel of the Bureau of Fisheries and Aquatic Resources, the Coast Guard, the Philippine Constabulary and municipal officials to enforce fishery regulations. Letter of Instruction No. 550 (dated 6 June 1977) also deputizes *barangay* (village-level) officials as fish wardens. However, none of these personnel and officials has an adequately functioning vessel to patrol the Bay.

The March 1982 ban on commercial fishing using vessels > 3 GT within the Bay was enforced at its outset by medium trawlers commissioned by the Regional Office of BFAR. However, this enforcement of the ban was short-lived. It is easy of course to say that if only existing legislation were enforced, the problems of competition and conflict between small-scale and trawl gears could be avoided. Certainly, confinement of small trawlers to that 15% area of the Bay where they can legally operate would do much to shift the distribution of catch and incomes from the large-scale trawl fishery in favor of the non-trawl fishery. This problem (and potential solution) is also present in other fishing grounds of the country, such as Manila Bay (Mariano 1981).

#### 4. Management Options

##### INTRODUCTION

Despite the attempts to regulate the operation of certain gear types in San Miguel Bay as described earlier, lack of enforcement has led to a *laissez-faire* approach to management of the Bay's fisheries.

The fisheries literature abounds with theoretical and empirical arguments against *laissez-faire* approaches to open-access fisheries because the social costs of wasting resources (or dissipating resource rents) are so high. The major theoretical works include those with biological perspectives (Baranov 1925; Graham 1935; Schaefer 1954; Beverton and Holt 1956; Gulland 1974) and economic perspectives (Gordon 1954; Scott 1955; Christy and Scott 1965; Anderson 1977). Anthropologists and sociologists are also contributors to fisheries management perspectives but have focused almost exclusively upon empirical studies (e.g., Firth 1966; Alexander 1982). Other more recent works from the above disciplines are too numerous to cite in full here, but the interested reader can refer to Smith (1979), Pauly (1979a), Emmerson (1980) and Panayotou (1982) for Southeast Asian examples and experiences, useful summaries and bibliographies. Because of the tendency worldwide for fisheries to become overexploited, establishing use rights or restrictions of some form to control levels of effective fishing effort is now an accepted prerequisite for the management of any fishery.

The rationale for restricting fishing effort varies depending upon the underlying management objective chosen. The three most commonly cited objectives include:

- to increase the annual sustainable yield from the fishery;
- to increase the annual resource rents derived from the fishery;
- to increase employment or more equitably distribute incomes derived from the fishery.

These objectives are, respectively, biological, economic and socioeconomic in nature and each would be associated with a different level of effective fishing effort.

Notice that the terms "increase" and "more equitably" are used rather than the term "optimize". This choice of terminology implies an interest in determining the direction and type of change in fishing effort rather than in determining precisely the 'optimal level' of fishing effort. Pinpointing the optimal level of fishing effort would depend not only upon the chosen management objective but also would require a scientific database of a time-series nature that is simply not available for San Miguel Bay or most other Southeast Asian fisheries.

For the sake of exposition, however, the economic (or efficiency) rationale for management can be pursued. The exact magnitude of the sustainable resource rents that can be derived from any fishery as a result of reductions in effective fishing effort depends, among other factors, upon:

- the shape of the sustainable yield (or total revenue) curve (e.g., parabolic, logarithmic and skewed to the right, or flat-topped—see Fig. 4, p. 11);
- future shifts in species composition (resulting from changes in levels of effort) that result in changes in total revenue;
- the shape of the total costs curve;
- future shifts in total costs (e.g., fuel price increases);
- future shifts in demand and relative prices of the species that make up the catch and which result in changes in total revenue; and
- the degree to which effective fishing effort is actually controlled or limited.

There are highly sophisticated mathematical dynamic models available which can be used to simulate alternative outcomes due to changes in these and other bioeconomic variables. However, the assumptions that would have to be made in order to use these models with the limited data currently available for San Miguel Bay suggest that this approach would not be fruitful. Consequently, the following evaluation of management options for San Miguel Bay fisheries must necessarily be primarily qualitative in nature.

It is perhaps helpful to clarify what is known and what is not known about these bioeconomic aspects of the San Miguel Bay fisheries before proceeding to an in-depth analysis of management options. With cost and revenue data available for a 12-month period in 1980-81, it was estimated that the total value of the catch based on ex-vessel prices was ₱53 million\*; that total costs (including fuel taxes) were ₱50 million (leaving ₱3 million of resource rents accruing to the Bay's fishing units); that the government earned a ₱5 million share of the resource rent through its tax on fuel; and that fuel suppliers/processors reduced the value of the catch to fishermen through their oligopoly/oligopsony power and earned approximately ₱2 million resource rent. Total resource rent from the fishery thus was approximately ₱10 million, or nearly 20% of the annual value of the fishery. The relative magnitudes of these estimates are more important than their exact values. It is worth noting in this context that the ₱53 million value of the fishery in 1980-81 may have been above, below or on the *sustainable* total revenue curve. Only time series data could resolve whether current revenue and resource rents are sustainable. Fig. 13 depicts these estimates in a relative way which serves as a useful framework for discussion.

The exact shapes of the costs and revenue curves are not known, although results of the present study suggest that the yield curve (on which the revenue curve would be based) most likely levels off at the high levels of effort that presently are applied in San Miguel Bay. The underlying yield curve of this multispecies fishery is thus assumed to differ from the traditional single-species Schaefer sustainable yield curve which is parabolic in shape (see Larkin 1982 for an extended discussion). Changes in species composition as effort changes therefore may produce a total revenue curve that is also flat-topped. In other words, *increases* in effective effort will not generate a noticeable increase in annual catch or revenues but would reduce resource rents, while *reductions* in effort

\*Not included in the above annual catch value estimate is the value of that portion of the catch taken home by the crew for their family's consumption. Based on number of fishermen ( $\approx 5,000$ ), average number of days fished per year (250 days), average volume of daily take-home catch (0.7 kg) valued at ₱2.87/kg, the total annual value of this home consumed catch would be approximately ₱2.5 million. See Stevenson et al. (1982) for rationale for making these computations earlier in a study than done here.

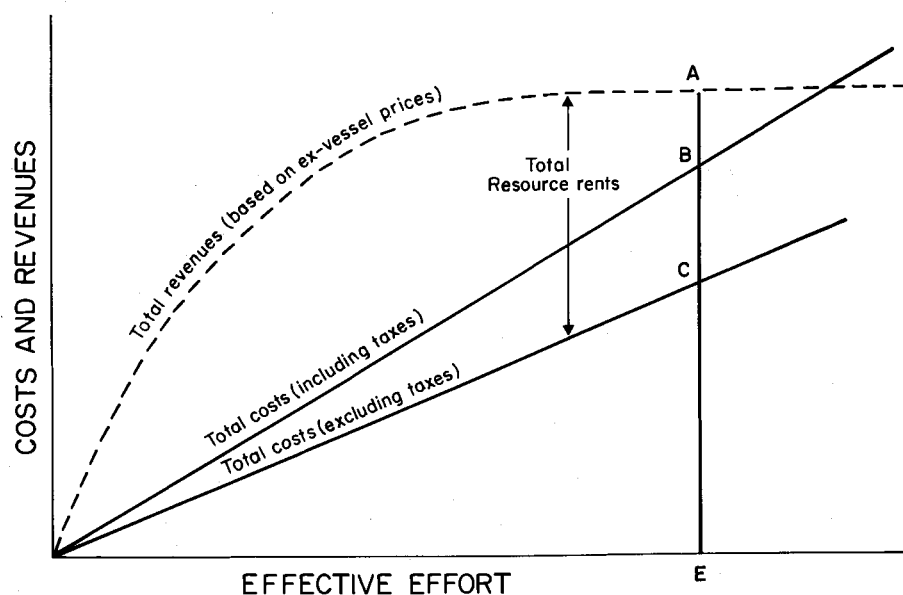

Fig. 13. Relationships between effective effort and total costs and revenues in the multispecies fishery of San Miguel Bay. At level of effort E, AB equals resource rents accruing to fishermen; BC equals resource rents accruing to the tax authority; CE equals total of all direct and imputed (opportunity) costs of all inputs (less taxes); AE equals the total revenue based on prices received by fishermen (including in-kind home consumption and adjusted for oligopoly/oligopsony profits of input suppliers and middlemen).



would produce a slight reduction in annual catch and revenues, but would substantially increase resource rents. If it is assumed that total costs decline with reductions in effort, then at some unspecified but reduced level of effort, these resource rents will be maximized.

The presence of positive resource rents as in the case of San Miguel Bay could lead to the interpretation that at current levels of fishing effort, resource rents are already at their highest level. Accepting this conclusion would imply that present levels of catch and total revenues would increase with increasing fishing effort (though the increased costs associated with increased effort would thus reduce resource rents); conversely, a reduction in effort would reduce not only catch and total revenues, but also resource rents. The already extremely high levels of catch per unit area for the Bay suggest, however, that the fishery is now operating somewhere in the upper right hand section of Fig. 13 where reductions in effort would yield increased resource rents.

These increased resource rents represent potential savings that are currently being 'wasted' due to excessive levels of effort and costs (i.e., inefficiency) in the fishery. If 'saved' they could be invested to produce other goods in the economy and total production of 'all goods' would increase.

The potential benefits from management in the form of reduced costs which lead to increased resource rents can be substantial. Van Cleve (1978), for example, believes that at least 5 million tonnes of fish are lost annually worldwide due to overfishing which produces yields less than those which are sustainable under optimum conditions. Gulland (1982) estimates that US\$500 million are wasted annually in the North Sea alone through lack of control over fishing effort. Other more specialized studies of lobster fisheries in Australia (Meany 1979), Canada (Henderson and Tugwell 1979) and the United States (Bell and Fullenbaum 1973; Fullenbaum and Bell 1974) have concluded that maximum annual resource rents may be as high as 25% of the current annual total value of these fisheries. These authors and Nahan (1982) who studied Malaysian West Coast fisheries, showed that optimum levels of fishing effort (those levels which produce maximum resource rents) would be anywhere between one-quarter and two-thirds of those levels of effort which prevail at open-access equilibrium.

The above scenario and comparison with results elsewhere is the essence in simple terms of the bioeconomic argument for managing, or controlling levels of effort in the San Miguel Bay fisheries. Precise determination of the optimum fleet size or level of effort is difficult under even the most favorable circumstances due to the dynamic nature of multispecies fisheries. Nevertheless, even when limited historical data on costs and revenues are available, the direction of desirable change can still be identified. Even this first step is a significant advance.

Other considerations, such as employment and income distribution, modify this bioeconomic perspective to the extent that they depart from the efficiency criteria of increasing resource rents (Panayotou 1982). Increasing employment in the fishery, for example, will entail increases in fishing effort rather than the reductions in effort which would increase resource rents. Changing the distribution of income derived from the fishery may entail incentives or disincentives for certain types of vessels or gear which may increase costs and hence reduce resource rents.

Multigear fisheries such as San Miguel Bay present particular problems in analysis and setting of management objectives because it is not possible to assume, as do most theoretical single-species bioeconomic models, that all fishing units in the fishery have uniform costs. The data assembled for the San Miguel Bay fishery indicate markedly different costs between gill-netters and trawlers, for example, and varying degrees of efficiency and financial profitability. Because costs (and government taxes) are not distributed evenly among all fishing units in the Bay, and catch rates and prices also vary, resource rents (and therefore incomes) are also distributed unevenly.

This diversity among the small-scale and large-scale fisheries of San Miguel Bay does not mean, however, that the basic conceptual framework as depicted in Fig. 13 does not apply. Rather, the underlying relationships among catch, catch value, effort, costs and resource rents are valid and help establish in which direction levels of fishing effort should move.

The realities of tropical fisheries management are such that managers need advice now, even based on limited information, rather than later at the leisure of research scientists who would undoubtedly prefer a more perfect world and certainly more complete knowledge. Some interventions appear to be necessary in San Miguel Bay to rectify a deteriorating biological, economic and social environment for the majority of the Bay's fishermen. It is in the spirit of trying to clarify fisheries management options despite our admittedly incomplete knowledge that the remaining sections of this chapter are written.

#### ALTERNATIVE MANAGEMENT OBJECTIVES AND INTERVENTIONS

The intervention(s) chosen for a given fishery should depend upon the conditions of that fishery and the management objectives selected. There has been a tendency in Philippine fisheries circles (and elsewhere in the world) to think in terms of better boats and gear, credit schemes, input subsidies and community cooperatives or associations as the most appropriate forms of intervention by which small-scale fishermen can be assisted. These types of interventions have been characterized by Smith (1980) and Smith et al. (1980) as 'development' oriented in contrast to 'management' oriented. Development oriented approaches are those that directly or indirectly lead to increases in effective fishing effort; management, in contrast, places limits on levels of effective fishing effort. The potential impact of the traditional development approaches to small-scale fisheries are more fully explored in Smith (1979) and Panayotou (1982). Given that in San Miguel Bay further expansion of fishing effort will merely dissipate the remaining resource rents that accrue to fishermen and hence not increase incomes, these traditional development approaches will not be further discussed in this report except as they relate to interventions in the marketing sector, where they only indirectly affect the harvesting activity and the levels of effort applied.

The complexity surrounding the choice of management objectives and alternative interventions suggests the best means of clarifying them would be to limit the discussion to the major points only. The interested reader can refer to Pauly and Murphy (1982) and Gulland (1974) for extensive consideration of biological perspectives on management and Anderson (1977) and Panayotou (1982) for economic perspectives. The following discussion focuses upon the practical application of these theoretical perspectives to the special conditions of San Miguel Bay.

#### Management objectives

There are obviously numerous management objectives that can be considered for San Miguel Bay fisheries depending upon how broadly one defines management. Not only can the objectives considered include the production or harvesting sector but also input supply, processing and marketing. A comprehensive plan that includes not only vertical relationships within the fisheries sector but also horizontal linkages with other sectors in the rural and urban economy of Bicol could also be developed.

Fisheries biologists and economists often think of fisheries management in rather narrow terms related only to the harvest sector. While this report focuses primarily on management of the harvesting sector of the fishery, certain broader issues related to input and marketing sectors and the rural economy of which the San Miguel Bay fisheries are also considered. This broader focus is necessary, as will be shown, to provide a longer-term perspective of the potential for management of the fisheries in the context of technological advancement, steady population growth, and economic conditions prevailing in the Bicol region.

With this broader context in mind, alternative management objectives for San Miguel Bay fisheries and fishing communities can be grouped into three major categories:

- (a) Those related specifically to the harvesting sector of the fishery. For example,
  - to increase the sustainable yield from the fishery;

- to increase the economic efficiency of the fishery;
  - to increase employment in fishing;
  - to provide more equitable distribution of income between labor and owners of capital or among gear types;
  - to raise incomes of fishermen above the poverty threshold;
  - to reduce environmental degradation in the Bay;
  - to reduce conflict between the small-scale and large-scale sectors of the fishery;
  - to increase government revenues from the fishery;
  - to provide conditions conducive for innovation among fishermen in order to maintain efficiency and income levels;
  - to increase production of exportable species to earn foreign exchange.
- (b) Those related to linkages between the harvesting sector and other sectors, such as inputs and marketing. For example,
- to improve the technical and economic efficiency of the input supply, processing and marketing sectors;
  - to increase opportunities for village employment in the input supply, processing and marketing sectors.
- (c) Those related to the Bicol regional economy. For example,
- to maintain social and political stability in the fishing communities surrounding San Miguel Bay;
  - to provide sufficiently attractive alternative income sources in the area of San Miguel Bay so as to reduce dependence upon fishing.

Given the prevailing conditions in the San Miguel Bay fisheries, achieving most of the objectives listed in the first category above will require some reallocation if not reduction in levels of effective fishing effort. This is because the current high levels of effort in both the small-scale and large-scale sectors have produced economic overfishing and skewed distribution of benefits from the fishery.

The first group of objectives also includes items that are mutually exclusive. For example, given the likely flat-topped shape of the yield curve, it is not possible to increase the sustainable yield from the fishery and at the same time increase its economic efficiency. The former is achieved at current levels of effort while the latter would require reduced effort to increase the difference between revenues and costs. These types of incompatibilities in objectives commonly show up in national fisheries development plans that seek to be "all things to all people" by simultaneously calling for maximum output and employment for producers, maximum nutrition at minimum prices to consumers and maximum foreign exchange earnings for the government (Lawson 1978). For example, the Philippine fisheries plan has been described by Samson (1982):

The primary objective of the government for fisheries development is the maintenance of **self-sufficiency** in fish supply. The underlying reasons for this concern are the traditional reliance on fish as food and fishing as a countryside activity. The government has a declared commitment to the **rational exploitation** of the country's fishery resources, **improved handling and distribution**, **uplifting the livelihood** of rural fishing families and the **generation of foreign exchange through exports**. (emphases added)

Certainly in the case of fisheries such as San Miguel Bay where the biological limits to expansion have been reached, management will necessitate choosing a set from among all possible objectives, or at the very least ranking them according to priority. This is especially true of those objectives related to managing the production or harvesting sector.

The second category of management objectives above includes those that do not require reductions in effective fishing effort per se, but which cannot be overlooked if one takes a comprehensive view of the fisheries. Some of the objectives listed in the third category can be more easily achieved if agreement is reached on those in the first category. Achieving social and political stability in the area, for example, may be assisted by agreement on management objectives related to allocation of use rights and benefits of the fisheries. Of course there are other means to assure

peace and order such as the use of force but this approach adds to the "costs" of fisheries management, and may be a more expensive approach than taking steps to reduce the potential for competition and conflict between the small-scale and large-scale fisheries.

As researchers, the authors of this report are not themselves recommending any specific management approach. The selection of specific management objectives should come from those institutions and fishing communities that have the legal mandate to manage the Bay's fisheries. Given the alternative objectives presented above for the consideration of these institutions and communities, the discussion in this report explores the various means by which these alternative objectives can be achieved and the trade-offs in qualitative terms among the different interventions.

### Management interventions

Before discussing alternative interventions, it is worth recalling that the current status of the fisheries of San Miguel Bay is the result of past and current interventions. The major interventions included credit for municipal fishermen (little of which was repaid), attempts to demarcate areas for trawl fishing, assignment of fishing rights for placement of certain fixed gears by *amonojadores*, differential government taxes on diesel fuel and gasoline (higher on gasoline than on diesel), and construction of all-weather roads to communities at the southern base and northwest opening of the Bay.

For each management objective listed in the preceding section, the alternative interventions that might be considered to achieve that objective are presented in Table 15. Some of the listed objectives can be achieved by maintaining the status quo and thus may not require specific interventions other than those already existing. Others simply may require enforcement of existing regulations.

Table 15. Alternative management objectives for San Miguel Bay and alternative interventions needed (if any) to address each objective.

Alternative objectives	Alternative interventions
A. Objectives related to harvest sector	
● Increase sustainable yield	Maximum yield probably achieved under current conditions, but stabilization of effort or control over size at first capture (e.g., increase minimum mesh size) required to avoid long-term decline in trawlable biomass and further changes in species composition.
● Increase economic efficiency (i.e., resource rents)	Encourage innovation and progressiveness to reduce fishing costs. Substantial reduction in effort and costs required; numerous specific interventions can be considered (e.g., quotas, licenses, taxes, selective price controls, area or seasonal closures). Decision also needed as to which gear types should be regulated and whether to leave increased rents in the fishery or to extract for use by institutions other than fishermen.
● Increase employment in fishing	Restrict capital-intensive gear types; maintain most of the current large-mesh nets of the small-scale fishery and increase some others; allow continued unrestricted entry of small-scale fishermen; continue subsidized credit for small-scale labor intensive gear types.
● Provide conditions conducive to more equitable distribution of income (a) between labor (crewmen) and capital (owners); and	(a) No intervention in current sharing arrangements necessary as present systems appear responsive to respective opportunity costs; labor share can be increased by increasing labor opportunity costs; encourage owner-operator fishing and discourage multiple ownership to make more crewmen become owners.

Continued

Table 15 continued

Alternative objectives	Alternative interventions
(b) among competing gear types	(b) Restrict certain gear types, especially small trawlers; introduce parity in taxes on inputs, especially gasoline and diesel fuel.
● Reduce conflicts between the large-scale and small-scale sectors	Enforce existing legislation; redefine 'municipal' fisheries to exclude small trawlers, then limit small-trawler numbers or areas of operation or ban them; establish trawling barriers in areas off limits to trawlers.
● Raise incomes of fishing households above the poverty threshold	Given prevailing low incomes throughout Bicol, long-term increases in fishing household incomes possible only through combination of (a) limited entry that excludes some fishermen thus benefitting those that remain, (b) alternative/supplementary income generation; short-term increases possible by subsidizing inputs or reducing taxes thereon (e.g., gasoline tax) used by small-scale fishermen; and (c) education programs that increase skills and mobility of fishing families.
● Reduce environmental impact of activities in and near the Bay	Siltation inflows due to upland agriculture activities, while causing gradual shallowing and reduction in Bay's area, also bring nutrients of probable benefit to the fishery; halt conversion of mangroves to alternative uses (e.g., fishponds).
● Increase government revenues from the fishery	Increase municipal license fees, taxes on inputs, catch and/or incomes so as to extract increased resource rent in favor of the government (municipal, provincial, regional or national).
● Increase production of exportable species to earn foreign exchange	No major intervention necessary; present conditions (e.g., siltation, fishing out of predators and trawling) are favorable to shrimp production. Increasing mesh size may increase average size of shrimps caught but would not necessarily increase total catch or catch value.
B. Objectives related to fisheries inputs and marketing sectors	
● Improve technical and economic efficiency of input supply, processing and marketing sectors	Encourage use of standard weights and measures; increase flow of price information from local markets to beach landings through channels other than those controlled by middlemen; improve landing and auction facilities, encourage better product handling and processing techniques; improve fuel supply and market roads to more remote communities.
● Increase opportunities for village employment in the input supply, processing and marketing sectors	Decentralize and increase number of processing establishments; provide credit to small-scale processing entrepreneurs; encourage community organizations to undertake group processing and marketing and organize the appropriate group (i.e., women, not men) to undertake these activities.
C. Objectives related to the regional economy	
● Provide sufficiently attractive alternative income sources. . . so as to reduce dependence upon fishing	General economic development and diversification in the Bicol Region to increase the presently low opportunity costs of fishing labor and capital; land reform for rice and non-rice land; investment incentives to decentralize Manila-based development; strengthening of local and regional institutions and delegation of authority to them. Specific activities for fishing communities may include small-scale agro-industry such as pig farming.
● Maintain social and political stability in the fishing communities surrounding San Miguel Bay	Generate local employment opportunities to reduce rural-urban migration; restrict certain efficient capital-intensive gear types viewed by the majority of fishermen as detrimental to their interests; strengthen military presence to keep "peace and order" or establish management institutions that permit fishermen involvement in decision-making regarding resource use and allocation.

Several objectives share appropriate interventions in common which allows them to be grouped for more in-depth evaluation and discussion. This grouping also draws attention to the fact that achieving one objective or another is often a matter of the degree to which the intervention in question is applied. For example, given the likely shape of the yield curve, maintaining sustainable yield from the fishery requires only that effective effort be prevented from expanding beyond current levels. Increasing economic efficiency requires a reduction in levels of effective effort. Significantly reducing areas of conflict between large-scale and small-scale fisheries may require even total elimination of one or the other sector. The degree of application of any particular intervention will thus depend upon the management objective or combination of objectives that are chosen by those with management authority.

Due to the restricted database, any evaluation of alternative management interventions must necessarily be qualitative in nature. Similar predictions based on theoretical models were used by Smith (1979) and Panayotou (1982). The latter's presentation of impacts of alternative interventions was a particularly useful base from which a matrix for San Miguel Bay was developed (Table 16). This matrix is indicative of the likely direction of change only. The following evaluation includes two major elements: (1) likely impact of management interventions on selected biological, economic and sociological parameters of the San Miguel Bay fishery; and (2) ability of the intervention to meet certain implementation criteria. The reference points for this evaluation are the results presented in Chapter 2 of this report and the relationships among yields, revenues, resource rents and fishing effort as depicted for the San Miguel Bay in Fig. 13, p. 37.

## DISCUSSION OF INTERVENTION MECHANISMS

### General issues

Interventions in the San Miguel Bay fisheries have impact not only upon the fish stocks (catch, sustainable yields, catch composition) and the fisheries (various gear types) but also upon fishing communities, the marketing system and institutions that presently share the costs, benefits or resource rents from the fisheries. Impacts make themselves felt in the short term and/or the long term. For example, impacts on tropical multispecies fish stocks due to effort reductions are felt in a short period due to the nature of these stocks which rebound quickly (Saeger 1981). In contrast, a decline in profitability for a certain gear type will take some time to translate into reduced fishing effort because fishermen will probably continue to fish as long as they cover their variable costs even though their fixed costs are not covered by their returns. Only when it comes time to replace vessels, engines or gear will some fishermen leave the fishery thus producing an overall reduction in effort.

Most management interventions needed in fisheries as in San Miguel Bay represent means of directly or indirectly reducing levels of effort in either the large-scale fishery, the small-scale fishery or both. Limitations on effort in the large-scale fishery will reduce that sector's share of the catch to the probable benefit of the small-scale sector, at least in the short term. In the very long term, increases in population (number of fishermen) and technological growth in the small-scale fisheries will eventually dissipate the temporary resource rents that would prevail with the reduced large-scale fishing effort. Indeed the existence of resource rents will likely attract new entrants at a rate higher than the population growth rate, other employment options remaining unchanged, after which small-scale fishermen would again be earning approximately their opportunity costs as they are now. Given the low levels of income that can presently be derived from alternative activities available to small-scale fishermen of San Miguel Bay (opportunity wage = ₱10-15 depending upon location) it is assumed in the analysis in Table 16 and the following discussion that it is not socially or politically feasible or desirable to limit entry or levels of effort in the small-scale fishery in any way. Consequently, the disincentives shown, with the exception of limiting ownership to single vessels, focus

**Table 16. Interventions mechanisms to limit access and/or effective effort in San Miguel Bay and their likely impact in qualitative terms in the short-term (ST) and/or long-term (LT) (relative time) where applicable (and if enforced) and criteria for implementation of management interventions (rated high (H), medium (M) or low (L) potential to meet criteria).**

	Biological impact				Economic and social impact										Institutional impact					
	Non-trawl catch	Trawl catch	Sustainable yield	% of trash fish in catch	Total value of fishery	Resource rents	Av. costs of fishing	Non-trawl incomes (average)	Trawl incomes (average)	Fishing employment	Secondary employment	Government revenues	Geographic mobility	Age of fishing population	Strength of marketing network / <i>suakir</i>	Processors/fuel supply monopoly	Municipal authority	BFAR authority	Sharing systems	Community fishery related organizational/authority
<b>STATUS QUO</b> (no enforcement of existing regulation and no control over effective effort; nominal trawler license fees only)	↓	ST↑ LT↓	ST- LT↓	↑		↓	↑	-	↓	↓	-	-	↑	↑	-	-	-	-	-	-
● Increase trawl mesh size	ST↑ LT↑	ST↓ LT↑	ST- LT↑	LT↓	ST- LT?	ST↓ LT-	ST↑ LT↓	ST↑ LT-	ST↓ LT-	ST↑ LT↑	ST↓ LT↑	↓	ST↓ LT↓	↑	↑	↑	↑	-	-	↑
● Licenses for trawlers																				
- Reduced number of trawler licenses auctioned to highest bidders	↑	↓	-	↓	ST↓ LT-	ST↑ LT-	↑	ST↑ LT-	ST↑ LT-	ST↓ LT↑	ST↓ LT-	↑	ST- LT↑	-	↑	↑	↑	↑	-	↑
- Grandfather/buyback of trawlers (p. 51)	ST- LT↑	ST- LT↓	-	ST- LT↓	-	ST↑ LT-	↑	ST- LT-	ST- LT-	ST- LT↑	-	↓	ST- LT↑	-	↑	↑	↑	↑	-	-
- Single trawler per owner	ST↓ LT-	ST↓ LT-	-	-	ST↓ LT-	ST↑ LT-	ST↓ LT-	ST↓ LT-	ST↓ LT-	ST↓ LT-	ST↓ LT-	-	ST- LT↑	-	↑	↓	↑	-	-	↑
● Catch quotas (set below present levels of catch)																				
- Fleet (trawlers)	↑	↓	ST↓ LT-	↓	ST↓ LT-	ST↑ LT-	↑	ST↑ LT-	↓	↑	ST↓ LT-	-	ST↓ LT-	-	↑	↑	↑	↑	-	↑
- Individual trawlers	↑	↓	ST↓ LT-	↓	ST↓ LT-	ST↑ LT-	↑	ST↑ LT-	↓	↑	ST↓ LT-	-	ST↓ LT-	-	↑	↑	↑	↑	-	↑
● Taxes																				
- On gasoline fuel	↓	↑	-	↑	↓	↑	↑	LT- LT-	LT- LT-	↓	↓	↑	↑	↑	-	↑	-	-	-	-
- On diesel fuel	↑	↓	-	↓	↓	↓	↓	LT- LT-	LT- LT-	↓	↓	↑	↑	↑	-	↑	-	-	-	-
- On catch	↓	↓	↓	↓	↓	↑	↑	LT- LT-	LT- LT-	↓	↓	↑	↑	↑	↑	↑	↑	↑	-	↑
- On exports (i.e., shrimp)	-	↓	↓	↓	↓	↑	↑	-	ST↓ LT-	↓	↓	↑	↑	↑	-	-	-	-	-	-
- On incomes (progressive)	↓	↓	↓	↓	↓	-	-	ST↓ LT-	ST↓ LT-	↓	↓	↑	↑	↑	-	-	-	-	-	-
● Price controls (ceilings)																				
- On selected species	↓	↓	↓	↓	↓	-	-	-	-	↓	↓	-	↑	↑	↑	↑	↑	↑	-	↑
- At retail level	↓	↓	↓	↓	↓	-	-	-	-	↓	↓	-	↑	↑	↑	↑	↑	↑	-	↑
● Area closures (to trawlers)	↑	↓	ST↓ LT-	↓	ST↓ LT-	ST↑ LT-	↑	ST↑ LT-	ST↓ LT-	↑	ST↓ LT-	-	ST↓ LT-	-	↑	↑	-	-	-	↑
● Seasonal closures																				
- Gear specific (trawlers)	↑	↓	ST↓ LT-	↓	ST↓ LT-	ST↑ LT-	↑	ST↑ LT-	ST↓ LT-	↓	↓	-	-	-	↑	↑	↑	↑	-	↑
- Species specific																				
● Trawler restrictions																				
- Selective bans (small trawlers only)	↑	↓	ST↓ LT-	↓	ST↓ LT-	ST↑ LT-	↑	ST↑ LT-	↓	↑	ST↓ LT-	-	ST↓ LT-	-	↑	↑	↑	↑	-	↑
- Total bans (all trawlers including mini trawlers)	↑	↓	ST↓ LT-	↓	ST↓ LT-	ST↑ LT-	↑	ST↑ LT-	↓	↑	ST↓ LT-	-	ST↓ LT-	-	↑	↑	↑	↑	-	↑
- Obstacles on seafloor	↑	↓	ST↓ LT-	↓	ST↓ LT-	ST↑ LT-	↑	ST↑ LT-	↓	↑	ST↓ LT-	-	ST↓ LT-	-	↑	↑	↑	↑	-	↑
<b>INCENTIVES</b>																				
● Alternative or supplementary income	-	-	-	-	-	-	↑	↑	↑	?	-	-	↑	↑	-	-	-	-	↑ labor share	-
● Marketing improvements	↓	↓	↓	-	↑	ST↑ LT-	-	ST↑ LT-	ST↑ LT-	↓	↓	-	-	-	↓	↓	-	-	-	-
● Educational programs	↓	↓	-	-	↑	↓	↓	↑	-	-	-	-	-	-	-	-	-	-	↑ labor share	-

ST↑ = short-term increase; LT↑ = long-term increase; ST↓ = short-term decrease; LT↓ = long-term decrease; - = no change; LT- = no change in long term; ST- = no change in short term; ? = unknown; ↑ = short and long-term increase; ↓ = short and long-term decrease.

Table 16. Continued

	Implementation criteria								Limitations
	Enforceability	Administrative simplicity	Administrative cost	Equity of distribution of benefits	Flexibility/adaptability	Participatory (by fishermen)	Dislocation	Avoidance/corruptability	
STATUS QUO (no enforcement of existing regulation and no control over effective effort; nominal trawler license fees only)									Increased social unrest; present nominal license fees do not limit entry or effort.
● Increase trawl mesh size	L	H	L	H	H	H	L	H	Does not limit effective effort of trawlers in the long run because other components of effort can still expand. Also difficult to enforce.
● Licenses for trawlers									
– Reduced number of trawler licenses auctioned to highest bidders	M	H	M	L	H	H	M	M	Despite limitation on number or effort of trawlers, long-term growth in numbers of non-trawl fishermen will result in no long-term benefits, but increased resource rents and government revenues in the short term.
– Grandfather/buyback of trawlers (p. 51)	M	L	M	H	H	H	L	M	Provides gradual phase out of trawlers, but does not restrict gradual increases in effort in the non-trawl sector; a useful short to medium term strategy, but cost to government is high.
– Single trawler per owner	L	H	M	H	n/a	H	M	M	May reduce fishing employment in short term until boat ownership fully dispersed. Does not provide long-term control over expansion of fleet size.
● Catch quotas (set below present levels of catch)									
– Fleet (trawlers)	L	L	H	M	H	H	M	M	Establishing quotas for fleet or individual vessels extremely complex. Even if quota is established, vessel upgrading and gear improvement would still occur, thus still resulting in overcapitalization. Probably impossible to enforce, in any case.
– Individual trawlers	L	L	H	M	H	H	M	H	
● Taxes									
– On gasoline fuel	H	H	L	L	H	L	M	L	Tax rates could be selectively applied; for example, increasing diesel fuel tax only would increase parity with gasoline taxes, reduce trawler fleet effort and thus produce a more equitable situation vis a vis the non-trawl fleet.
– On diesel fuel	L	L	H	L	M	L	M	H	Substantial objections from fishermen likely.
– On catch	H	H	M	H	H	L	M	L	Tax collections could be centralized. Leaves problem of distribution and use of additional revenues unresolved; no special benefits to the fishery sector may result.
– On exports (i.e., shrimp)	L	L	H	H	H	L	L	H	Special income tax for fishermen unenforceable in general context of widespread tax avoidance.
– On incomes (progressive)									
● Price controls (ceilings)									
– On selected species	L	L	H	L	L	L	M	L	Only price ceilings discussed here; price floors (which may represent subsidies at certain times) are not considered a management intervention but rather one which is designed to stimulate fishing effort.
– At retail level	M	L	H	L	L	L	H	L	Unenforceable; fishermen will fail to understand reason why price control would be in their long-term interest. Seasonality in supply and prices will require setting of ceiling prices on a frequent basis. Potentially more enforceable, but differences among fishing costs at different locations around the country imply differential impact.
● Area closures (to trawlers)	L	M	M	H	H	H	H	H	Difficulties in enforcing present area restrictions provide indication of potential difficulties and costs in any area restriction without reorganization of management authority to include community participation and ability of non-trawl fishermen to enforce.
● Seasonal closures									
– Gear specific (trawlers)	H	H	L	H	H	H	M	L	Multispecies nature of fisheries makes prediction of effects difficult. Greater idleness of fleets and processing establishments during the closure. Species-specific seasonal closure generally not possible, except for anchovy by mandating increased mesh size for trawlers during anchovy season. Anchovies could then be harvested solely by non-trawl liftnets. Extremely difficult to implement in a multispecies multigear fishery.
– Species specific									
● Trawler restrictions									
– Selective bans (small trawlers only)	H	H	L	H	n/a	H	M	L	Level of dislocation is high if implemented with no warning.
– Total bans (all trawlers including mini trawlers)	H	H	L	H	n/a	H	H	L	Unnecessary negative impact on mini trawlers at present; sergestid shrimp may become over-exploited in the future, however, thus requiring regulation of mini trawlers.
– Obstacles on seafloor	H	H	H	H	n/a	L	H	L	Negative impact on mini trawlers.
● Alternative or supplementary income	n/a	L	H	H	H	H	L	n/a	Only approach which leads to increases in fishing incomes in the long run.
● Marketing improvements	n/a	L	H	H	H	L	L	n/a	Marketing improvements, by increasing prices received, lead to further entry and dissipation of resource rents in the long run, but possibly generate additional secondary employment with labor intensive processing at the fishing household level.
● Educational programs	n/a	L	H	H	H	H	L	n/a	To the extent that education permits individuals to take better advantage of other non-fishing opportunities, investment in education will also lead to lower levels of fishing entry and effort than would otherwise be the case.

DISINCENTIVES

INCENTIVES



upon means of reducing effective effort in the large-scale fishery, particularly that of the small trawlers.

There are also sound economic arguments related to the relative efficiency of the small-scale and large-scale fisheries for considering restrictions only on the latter. If one considers only the private financial profitability of the small-scale and large-scale fleets, it would appear that the fish corrals, mini trawlers and small trawlers are the most efficient gears. Of these gear types, small trawlers earned the largest annual pure profits (P26,900) per unit and therefore at first glance appear to be the most efficient. However, this relative efficiency (when compared to small-scale gears such as gill-netters) is artificial since it is only made possible because of the fuel tax differential that favors those vessels, such as small trawlers, that use diesel fuel. If small trawlers paid the same fuel tax per liter that is presently paid on regular gasoline, instead of pure profits (resource rents) each unit would have incurred losses exceeding P30,000 annually.

This conclusion provides evidence to support the view that large-scale industrial fisheries are often subsidized directly or indirectly relative to small-scale fisheries (Garcia 1983). Though lower taxes on diesel fuel are viewed by the national government as conducive to industrialization in the economy as a whole, they have had a negative effect on small-scale fisheries that find themselves in competition with small and medium (so-called "baby") trawlers.

In the case of San Miguel Bay, the small-scale fisheries have also been subsidized in the past to the extent that much of the credit granted for vessel, gear and engine purposes during the 1970s was never repaid. However, there are two differences between the benefits derived by the large-scale sector from the tax differential and by the small-scale sector from the credit subsidies. First, the fuel tax differential in effect reduces operating costs of small trawlers which produces benefits that are then spread according to the sharing systems between the crew (labor) and the owner (capital). In the case of the credit subsidy for the small-scale fishery, owners were the primary beneficiaries while crewmen benefited only to the extent that they were enabled to become owners themselves. As noted in previous reports, a portion of this small-scale fishery credit never found its way into the hands of bona fide fishermen (see also FIDC and TBAC 1983).

The second difference between the two subsidies is more important because it is likely to have a much greater impact on the relative competitiveness of the two fishery sectors in the future. This difference is that the fuel tax differential is certain to continue in years to come while small-scale fishery credit programs will almost certainly diminish in scope and size. The current crisis facing the Philippine economy and the low repayment rates of previous credit programs that have been coursed through the rural banking system have made any major new small-scale fisheries credit initiatives highly unlikely for the foreseeable future. Consequently, the financial picture for individual gear types which is described in earlier chapters of this report (and which included depreciation and opportunity costs of capital on the assumption that vessel/gear owners were financing their own capital investments) is the picture likely to prevail in the future. Therefore, the large-scale fishery (small trawlers especially) will retain their competitive edge over the small-scale fishery (particularly gill-netters) even though they are in reality less efficient in the economic sense. If an efficiency related management objective is thus deemed appropriate for San Miguel Bay, consideration could be given to enforcing existing regulations or establishing new restrictions over the activities of the large-scale fishery.

#### **Disincentives**

The alternative interventions that were listed by management objective in Table 15 have been grouped into disincentives and incentives in Table 16 and their short-term and longer-term impact on various parameters noted. Each intervention is evaluated according to a set of implementation criteria including enforceability, equitability, likely cost-effectiveness, flexibility and simplicity.

As indicated in Table 16, not all possible management intervention mechanisms will be practical for the San Miguel Bay fisheries. Catch quotas, price controls and seasonal closures all appear to be impractical, given the multispecies and multigear nature of the fisheries and the fact that San Miguel Bay is but one of many fisheries in the country contributing to national fish supply. Selective price controls on San Miguel Bay products would be quite impossible to implement.

Other intervention mechanisms in the category of disincentives—mesh size regulations, licenses, taxes, area closures and gear restrictions—offer more promise, however, to deal with problems of economic overfishing and skewed distribution of benefits, as do incentives. Each of these options is discussed in further detail below.

#### *Mesh size regulations*

Theoretically, controlling the age (size) of fish at first capture is one method to assure that cohorts are permitted to grow for a longer period of time and that total weight of the catch will thus increase. This theory is certainly true in single-species fisheries, but in multispecies multigear fisheries as occur in San Miguel Bay, the situation is more complicated.

Mesh of various sizes is used by small-scale vessels, such as gill-netters, but these gears tend to be highly selective and are changed seasonally depending upon the major species sought (Pauly and Mines 1982). In the Philippines, "commercial" vessels > 3 GT cannot legally use mesh sizes less than 2.5 cm, but there is no special regulation for small and mini trawlers. They are covered, however, by the general legal lower limit for all Philippine gears which is 2 cm. As shown in Navaluna (1982) and Pauly (1982) the present mesh size of 2 cm used by the San Miguel Bay small trawlers, combined with the high fishing mortality exerted by the trawler fleet, results in growth overfishing for literally all San Miguel Bay species, a problem which is enormously aggravated by the illegal 8-mm mesh used by these vessels during the anchovy season.

Based upon the method of Sinoda et al. (1979) it is possible to compute the mesh size for small trawlers which would optimize yield per recruit or value of the catch given prices prevailing in 1980-81. The method involves a series of steps, based on the data in Table 17. The steps are shown in Appendix B.

The optimum mesh size determined with this method is 5.3-5.4 cm or almost 3 times the size of that currently used by the small trawlers. It may be mentioned here that these values are similar to those estimated by Sinoda et al. (1979) for the Malacca Strait and the South China Sea, and by Meemeskul (1979) for the Gulf of Thailand although these authors did not include shrimps in their analysis, as was done here.

The above analysis does not allow for an estimation of the long-term increase in catch that would result from a transition to larger meshes in San Miguel Bay. In the short term, catch would diminish slightly with an increase in mesh size, with the decrease in catch being directly related to the magnitude of the mesh size increase. For this reason, and based only on biological considerations, the increase from the small trawl mesh sizes presently used (2 cm) to 5 cm could be spread over a few years, as follows:

- Year 1 announcement of proposed mesh size changes
- Year 2 enforcement of the ban of mesh sizes less than 2 cm (at present, meshes of 8 mm are used during the anchovy season)
- Year 3 minimum mesh size set at 3 cm
- Year 4 minimum mesh size set at 4 cm
- Year 5 minimum mesh size at 5 cm

Such staggering of the mesh size increase would most probably result in minimizing short-term losses in catch given the high regenerative capacity of Philippine demersal stocks (Saeger 1981). A year-by-year phasing would be appropriate because the average trawler replaces its nets each year. Mesh size regulations for the more selective non-trawl gears could also be similarly examined.

Table 17. Data for the computation of an optimum mesh size for the San Miguel Bay trawl fishery. See Appendix B for details.

No.	Statistical groups <sup>a</sup>	Representative species <sup>b</sup>	S.F. <sup>c</sup>	$L_{\infty}$ <sup>d</sup> (cm)	Optimum <sup>e</sup> mesh size ( $M_s$ )	Annual <sup>f</sup> catch (C)	Mean <sup>g</sup> price (P/kg)	Annual value (P x C)	Optimum mesh x catch ( $M_s$ x C)	Optimum mesh x value ( $M_s$ x V)
1	Sharks and rays	<i>Scoliodon parasorrah</i>	4.8	60	7.4	72	4.5	324	533	2,398
2	Anchovies	<i>Stolephorus indicus</i>	3.1	11	2.1	2,738	1.7	4,655	5,750	9,776
3	Sardines	<i>Sardinella albella</i>	2.3	13	3.3	402	2.8	1,126	1,327	3,716
4	Sea catfish	<i>Arius thalassinus</i>	2.2	150	40.2	12	3.0	36	482	1,447
5	Mulletts	<i>Liza subviridis</i>	2.3	40	10.3	660	2.7	1,782	6,798	18,355
6	Croakers (except <i>O. ruber</i> )	<i>Pennahia macrophthalmus</i>	2.4	22	5.4	626	2.8	1,753	3,380	9,466
7	<i>Otolithes ruber</i>	<i>Otolithes ruber</i>	2.4	30	7.4	818	2.1	1,718	6,053	12,713
8	Pomadasyds	<i>Pomadasyds hasta</i>	2.3	80	20.5	42	2.1	88	861	1,804
9	Small carangids (jacks)	<i>Selaroides leptolepis</i>	2.5	20	4.7	60	5.2	312	282	1,466
10	Large carangids (jacks)	<i>Carangoides malabaricus</i>	2.1	60	16.9	54	3.6	194	913	3,279
11	Small slipmouths	<i>Secutor insidiator</i>	1.8	8	2.6	40	2.0	80	104	208
12	Large slipmouths	<i>Leiognathus splendens</i>	1.8	14	4.6	36	2.0	72	166	331
13	Cutlass fish	<i>Trichiurus haumela</i>	6.2	100	9.5	508	1.7	864	4,826	8,208
14	Spanish mackerels	<i>Scomberomorus commersoni</i>	3.0	200	39.3	44	2.1	92	1,729	3,616
15	Squids	<i>Loligo</i> spp.	1.4	20	8.4	235	6.8	1,598	1,974	13,423
16	Shrimps	<i>Metapenaeus ensis</i>	1.5	10	3.9	461	17.9	8,252	1,798	32,183
						$\Sigma_1 = 6,808$	$\Sigma_2 = 22,946$	$\Sigma_3 = 36,976$	$\Sigma_4 = 122,389$	

<sup>a</sup>As defined in Pauly (1982), except that carangids and slipmouths were split into large and small, with slightly higher catches attributed to the smaller forms. Also note that crabs are not considered.

<sup>b</sup>Chosen as species with characteristics (size, body shape) typical of the group they represent.

<sup>c</sup>The selection factors (S.F.) were either taken from Sinoda et al. (1979) or Meemeskul (1979), or estimated from the body shapes, using the nomogram in Pauly (1980, Fig. 12).

<sup>d</sup>The estimates of asymptotic length were taken from Sinoda et al. (1979), Meemeskul (1979) or are maximum lengths given in Fischer and Whitehead (1974).

<sup>e</sup>Computed from equation 1 (see Appendix B).

<sup>f</sup>Obtained by adding to the catches in Pauly (1982) an equal amount representing the fraction of a given statistical group in the catch of "miscellaneous fishes" (which is about equal to the catch by taxonomic group, and essentially consists of the juveniles of these groups). This correction was not applied to the shrimps, nor to the squids.

<sup>g</sup>Obtained as the mean of the estimated mean price per kg for a given group and the price of miscellaneous fishes (see footnote (f)). The price for shrimps and squids, however were not corrected, as no "miscellaneous fish" components were added to their catch (see f). The prices used in this column are average prices received by fishermen in the Cabusao area, during the year 1980-1981.

All other components of effort remaining unchanged, the long-term gains for the trawl fishery would be:

- relatively higher catches of larger fishes (i.e., reduction of the proportion of low value "trash" fishes)
- reduction of the *costs* involved in catching a given amount of fish.

As larger trawl meshes would catch less shrimps and very few anchovies, the non-trawl fishery for shrimps and anchovies could be intensified to the benefit of the majority of the Bay's fishermen using, in the case of the anchovies at least, gears that would be very selective (e.g., fixed gears with lights in the case of the anchovies) and thus exempt from the mesh size regulations imposed on the small trawlers.

It is difficult to say whether an increase in mesh size would, in addition to increasing the net value of the catch from the Bay, also increase the total catch in weight of fish and shrimps. The model used here cannot address this question as it does not allow for biological interactions. Thus, for example, it is possible that the reduced pressure on the larger fish would result in an increased natural mortality of the smaller fishes (via increased predation). This problem could be dealt with by monitoring the changes in catch levels and composition during the transition to larger meshes. Indeed, such monitoring of the effect of any management measure should be a major *raison d'être* of an information program in support of a management institution in the San Miguel Bay area in any case.

It is assumed, too, that other components of effective fishing effort, especially engine and net size in small trawlers, remain constant. If these other components increase as one would expect without explicit contrary regulation, increases in effective effort will offset any potential gains that can be realized by increasing mesh size. A final consideration is the enforceability of a new mesh size regulation. To date, the existing 2-cm regulation has not been effectively enforced in San Miguel Bay; consequently, any change in mesh size should only be made if it is accompanied by a serious attempt to enforce the new regulation in a consistent fashion that overcomes opportunities for avoidance and non-compliance.

In summary, this method for reducing effective fishing effort in the Bay has advantages of administrative simplicity, minimal dislocation, increased equitability between trawl and non-trawl gears and the opportunity for participatory involvement/enforcement by fishing community officials and organizations. This method of intervention, however, is only a partial method in that it neither controls *all* components of effective fishing effort of the large-scale fishery nor limits the slow but steady expansion of effort in the small-scale fishery brought about by population growth and technological improvements.

#### *Licenses*

The present licensing system in San Miguel Bay is ineffective, not only in terms of limiting entry because costs of licenses are low, but even in terms of providing an accurate inventory of fishing units. The sociology and economics research teams, for example, found that municipal lists of licensed vessels less than 3 GT were incomplete and thus insufficient for sampling frame purposes. When license fees *are* collected by municipalities, they are for nominal amounts only; small trawlers pay only ₱40-50 annually, for example.

Theoretically, higher license fees are an effective way of limiting entry to any fishery (Crutchfield 1979; Pearse 1980) and in practice this method has come into use with some success in certain temperate zone single-species fisheries such as lobsters in Australia (Meany 1979). The rationale behind a licensing scheme is that if the fee is placed at a high enough level, not only is entry limited due to the higher costs of fishing, but also resource rents are generated for the licensing authority, equivalent to some or all of the pure profits previously earned by the fishing units. Recall that small trawlers in San Miguel Bay earned ₱26,900 pure profits on average in 1980/81.

Legally, local municipalities in the Philippines are empowered to collect license fees for the operation of all 'municipal' fishing units including small trawlers. In the case of San Miguel Bay, if license fees were increased substantially, coordination among the coastal municipalities would be necessary, adding to the administrative complexity of any licensing scheme. If Calabanga, for example, were to raise its small trawler license fees, what would stop these trawlers from registering in the neighboring municipality of Cabusao, for example, where the fees might be lower?

The primary interest here is to evaluate the potential benefits from a licensing scheme to limit the number or effective effort of small trawlers in the Bay. There are numerous variations of licensing schemes that might be considered. Important factors that must be considered include:

- Who or what is licensed (e.g., the fishing unit, engines, owners of fishing units, or fishermen).
- The method by which licenses are awarded (e.g., automatically to all present users; by auction to highest bidders; by lottery; only to owner-operators).
- The fee for the license (e.g., awarded through bidding process; set arbitrarily by the licensing authority; based upon previous year's profits).
- The duration of the license period.
- The degree to which the license fee extracts the resource rent from the fishery (e.g., a low fee license issued to a limited number of small trawlers would have the effect of leaving any resource rents in the fishery to the benefit of all users to be used as they choose; a higher fee would extract resource rents for the licensing authority).
- The means for transferring licenses among fishermen or fishing units (e.g., retire from the fishery licenses of fishermen as they die or of fishing units as they become no longer operable; allow purchase of licenses on the open market; allow sons to inherit the license of their fathers; establish government 'buy back' schemes).

The possible permutations are obviously large and are not presented in detail here. However, certain guiding principles should be considered.

First, if the desire is to limit effective effort in the fishery it is important that the licenses specify exactly the characteristics of the fishing units to be licensed. As Pearse (1982) has pointed out, "the problem of overexpansion is not simply one of too many boats; the capacity of a fleet depends also on the fishing power of individual vessels." For example, engine size is a critical component of fishing effort; a scheme that licenses vessels without specifying maximum engine size will fail since increased engine size over time will offset any benefits gained by limiting numbers of vessels in the first place (see various papers in Rettig and Ginter 1978 and Sturgess and Meany 1982 for numerous examples). Any attempt by the management authority to progressively add restrictions on vessels or gear will probably be offset by fishermen as they innovate, thus adding to the costs of fishing and not solving the overcapitalization problem (Meany 1979; Pearse 1982). Pearse describes the distinct lack of success of limited entry programs around the world, due to failure to account for technological improvement and fishermen's ingenuity. He concludes:

many governments have undoubtedly been attracted by the administrative simplicity of rudimentary limits on entry. But these controls do nothing to eliminate the incentives of fishermen to expand their fishing power even when the fleet is already too big; indeed if such a scheme succeeds at all so that the returns to fishing increase, these incentives will be strengthened. However, while limited entry is not likely to offer an adequate fleet control policy, it may often be a useful first step in a broader fleet rationalization program. (emphasis added)

A second guiding principle relates to the generation of resource rent and its distribution. In Pearse's examples, the limited entry scheme potentially produces resource rents but innovation and technical improvements in unregulated components of fishing effort are still possible. This occurs because only the number of vessels is limited and resource rents are earned by the licensed fishermen. This resource rent could, however, be extracted from the fishery in the form of higher license fees. For example, in 1980-81 the average small trawler in San Miguel Bay earned a pure profit of approxi-

mately ₱27,000 (75 small trawlers earned slightly over ₱2 million pure profits). Hypothetically, if annual license fees were set at ₱27,000 instead of the present level of ₱40-50, much of the incentive for *fleet* expansion would be removed and municipal authorities could significantly increase their revenue. Nevertheless, individual fishing units would still wish to expand their fishing capacity and thus reduce their average costs in an attempt to generate pure profits again. Consequently, even with much higher license fees, vessel and gear upgrading would still continue as individual vessels sought an edge over their competitors. The result of this response would tend to be continued overcapitalization in the fleet, even if actual numbers of fishing units were reduced. License fees would thus need to control all elements of effective effort and to be made flexible and responsive to changing profitability in the fisheries.

One way to assure this is to award licenses initially based on competitive bidding and then allow these licenses to be exchanged on the open market, perhaps limiting the number of licenses that can be owned at any one time to a certain number per individual owner (one would have to be on particular lookout here for dummy bidders). This might be desirable if the licensing authority wished to maintain but not reduce fleet size. A reduction in fleet size over time could be obtained by mandating no new vessel construction (a "grandfather" clause) or even using the income from license fees to 'buy back' vessels in the fleet. A one-time bidding for licenses should result in their value being established at or near the level of the expected future profits (discounted for expected inflation) during the proposed duration of the license for the vessel type in question. Any increase in value of the license over time would accrue to the original owner, which he could then convert into cash by selling his license on the open market (if the licensing authority has decided to allow transferable licenses). Transferability without limitations on number that can be owned by a single individual is likely to result in concentration of ownership of the small trawler fleet as presently prevails.

The decision whether to extract the resource rent and put it in the public treasury or whether to leave it to accrue to licensees is important because of the potential economic or employment benefits that can be derived from its use. On the one hand, if left to the fishermen, this resource rent could be applied to other investments in the non-fishing sector (the purpose of the licensing scheme would be defeated if it were reinvested in the fishery), thus generating additional production and employment. The extent to which this re-investment would be beneficial would depend upon the multiplier effect of local investment. On the other hand, assuming that administrative costs of the licensing authority are less than the total license fees, then the additional revenue could be used for other purposes (e.g., for road improvements to fishing communities, health services, or even alternative income-generating projects, such as those now being undertaken by the *Kilusang Kabuhayan at Kaunlaran* national 'movement for economic progress' livelihood program). A careful evaluation of the costs of any licensing scheme and of the effectiveness of government investment would be necessary before a decision is made on this issue. Care should be taken not to simply establish a revenue absorbing administrative structure that produces no net positive benefit to the local economy.

#### *Taxes*

As shown in Table 16, taxes can be levied at several levels including: (1) inputs, such as fuel; (2) catch or landings; (3) exports; and (4) income. At present in Philippine fisheries, including San Miguel Bay, taxes are levied on fuel; the differential tax between gasoline and diesel fuel is significant as previously discussed. Some income tax is paid by San Miguel Bay fishermen, though the extent of avoidance is probably high as elsewhere throughout the country. Finally, some small levels of tax on catch are paid by operators of small and medium trawlers in Sabang, Calabanga but the low level of this tax makes it more of a landing-use tax than an inhibition to fishing.

The theoretical literature on fisheries management contains arguments in favor of taxes as a means of increasing economic efficiency of fisheries (see Anderson 1977; Strand and Norton 1980).

The Strand and Norton analysis concludes that taxes are more effective than landing rights and time/space/gear limitations in minimizing production costs, distributing benefits (to the government), redirecting effort effectively and maintaining competition. However, management and enforcement costs of any tax scheme are likely to be high. Pearse (1982) agrees that to be effective "the charges would have to be perfectly adjusted to account for the varying value of the catch and costs of fishing among species, areas and season, so that the administrative task would be formidable." To date, no major fishery is managed solely by use of landings taxes, which may be indicative of the potential costs and headaches of this approach.

Taxes on inputs are another matter, however, and in the Philippines the level of national government intervention is already high. As explained in detail earlier, the government levies taxes on regular gasoline (₱2.54/l) that are approximately equal to its wholesale cost. The tax on diesel fuel, which costs almost the same to produce as regular gasoline, is significantly less (₱0.46/l). The result of these differential taxes has been an indirect subsidy for the small and medium trawlers that use diesel engines. If these trawl vessels had to pay the same fuel tax as all motorized small-scale fishing units that use a standard, widely available, low-cost 16-hp gasoline engine, they would be operating at a loss. The fuel tax policy of the government has led to a greater expansion of the trawler fleet than would have been the case had the tax rates on the two fuels been equal.

Redressing the situation would require either a reduction in the regular gasoline tax, an increase in the diesel tax or some combination of both approaches. The situation is seriously complicated, of course, by the fact that both fuels are widely used throughout the Philippines, especially in the transportation, commercial fishing and agriculture sectors. In fact, the incentive for diesel use is a conscious decision of government to stimulate industrial development, apparently unaffected by the conditions it creates in the small-scale fisheries sector. The tax differential is perhaps best explained by a desire to keep costs down in sectors such as public transportation, agricultural production and commercial fishing which, in addition to being so important to the economy, have politically aware and active constituencies. There are also practical design-related problems in advocating use of diesel engines in small outrigger bancas.

Consequently, if the management authority wished to provide conditions conducive to more equitable distribution of income in the San Miguel Bay fisheries, it would probably be necessary to lower taxes on gasoline used by small-scale fishermen. This administratively difficult task could be handled in a practical way by the use of color additives in fuel destined for small-scale fisheries to discourage redirection of this lower-taxed fuel to other purposes. The costs of assuring compliance with such a scheme would be considerable, however. Conversely, a higher-taxed diesel fuel (also identified by color additives) could be used instead, but the administrative difficulties would remain. Finally, if there were a desire of the government to achieve taxation parity between large-scale and small-scale fishermen, a rebate scheme based on regular gasoline purchases could be considered.

Alternatively, a tax on shrimp exports might be considered. This tax would affect both small-scale and large-scale (trawl) fisheries of San Miguel Bay equally because they share almost equally in the harvesting of shrimp. Such a tax would also face serious opposition from shrimp exporters and especially from fishfarmers who are currently investing large sums in this business in response to attractive export prices for shrimps. It would also be inimical to the government's current drive to increase exports and hence foreign exchange earnings. Finally, an increase in the landings tax at Sabang, Calabanga, the home base of most of the fleet would be one possibility though this would probably only encourage trawlers to land their catch in Mercedes or elsewhere where the tax might be lower.

Because most tax measures are difficult to confine solely to large-scale fisheries, it thus appears unlikely that this option offers much hope for regulating effort in San Miguel Bay fisheries.

### *Area closures*

Little need be said about the potential of area closures in San Miguel Bay, because the current situation in the Bay is the result of such an approach to the management of fisheries throughout the country. What needs stressing, however, is that the enforcement of current legislation (p. 30) would do much to reduce the current problems of overcapitalization and skewed distribution of benefits. *The current situation prevails because of the lack of enforcement of existing regulations.*

Of all the intervention mechanisms described to this point, effective area closures are probably the easiest to administer. Purchase by enforcement agencies of a small number of vessels which could be used to enforce the existing area/depth restrictions (see Fig. 11, p. 33) would do much to remove the sources of contention in the San Miguel Bay fisheries. Coupled with mesh size restrictions, area closures could be most effective.

### *Gear restrictions*

There are both direct and indirect means available to control the level of fishing effort of the various gear types that operate in the Bay. As pointed out by others (Christy and Scott 1965; Anderson 1977; Smith 1979 and Panayotou 1982) gear restrictions are not an effective management tool if one's objectives are solely economic in nature. "Legislating inefficiency" in this manner simply increases the average costs in the fishery and makes it more difficult to compete with other fisheries producing similar products at lower costs. The arguments in favor of restrictions on more efficient gears are usually based on needs to maintain more labor-intensive gears, and are thus particularly relevant in economies with much underemployed labor with low labor opportunity costs.

The interesting aspect of the San Miguel Bay fisheries is that in good measure it is government fuel-tax policy which has encouraged the expansion of the capital-intensive small trawler fleet. Small trawlers are not inherently more efficient than the small-scale gear with which they compete. Consequently, if redressing the tax differential is not possible, and the management objective for the Bay is to increase employment opportunities in the fisheries, then consideration could be given to restrictions on the operation of small trawlers within the Bay.

Because they exceed 3 GT and are considered "commercial", medium and large trawlers are already banned totally from fishing in the Bay, though it is understood that despite this ban, medium trawlers continue to operate in the Bay. If all trawlers, including small trawlers were effectively banned, it would have a quite dramatic impact on the Bay's fisheries and on trawler and secondary employment.

Banning small trawlers would remove 75 fishing units that presently account for over one-third of the total catch in the Bay. Most of this catch is landed in Sabang, Calabanga where secondary employment in processing activities and transport is high. Banning small trawlers would have an immediate effect upon catch and secondary employment not to mention dislocation of the 500 crew members and their families. Presently, 10% of the fishing labor force in San Miguel Bay depend directly on the small trawlers for employment.

On the positive side, catch of the small-scale non-trawl fishing units would increase and probably immediately. The percentage of trash fish in the total catch would decline and catch would become more dispersed at the numerous small-scale landing places around the Bay. This dispersion of landings would add to marketing costs and perhaps reduce quality of high-valued species on the one hand, while increasing fishing community employment and incomes, on the other hand (except in Sabang, Calabanga). The trawlable biomass would probably increase quickly as stocks rebound due to the reduced fishing pressure.

### *Combinations of disincentives*

Many of the disincentives discussed in this section represent only partial solutions to the problems of limiting entry and/or effort in the San Miguel Bay fisheries. For example, mesh size regula-



tions and licenses by themselves do not control all components of fishing effort. Coastal area closures such as those which exist up to the 7-fm mark also do not necessarily limit total effort in the Bay unless fishing in the area beyond 7 fm is also restricted in some fashion, such as through licensing. Consequently, the 'best' management approach for San Miguel Bay and similar fisheries will most likely include some combination of management interventions and mechanisms, the exact mix depending upon the management objectives agreed upon.

Some of the mechanisms discussed earlier (e.g., licenses or taxes) can generate significant income for the managing authority; some cannot. For example, a final disincentive mechanism that might be considered is the placement of "artificial reefs" on the bottom of the Bay at unmarked locations in waters shallower than 7 fathoms which could serve as fish habitats and at the same time inhibit trawling except in the depths beyond 7 fm where it is now allowed. The capital costs for such a program need not be high if simple bamboo structures are used. But these impediments would also adversely affect even the slow moving (1 km/hr) mini trawlers and their specialty fishery which does not interfere (physically, biologically or economically) with other small-scale gears. This *balao* (sergestid shrimp) fishery is an important component in the Bay's fishery employment and income and should not be overlooked when evaluating options of regulating, or through obstacles inhibiting, the activity of the small trawlers.

In the past in the Philippines, political expediency has frequently led to rapid and drastic action regarding laws affecting fishing activities. When medium and large trawlers were banned from the Bay in 1982, for example, the time from promulgation of the new law to effectivity was only 2 weeks, giving the individuals affected little time to adjust to the dislocation. Granted the effect on large commercial trawlers was probably minimal. Still, a similar step in such rapid fashion against small trawlers would incur quite substantial hardship among those affected, particularly the owners of large numbers of boats, their crewmen and the processors and laborers that depend upon them. Various government compensation or "buy-back" programs and sufficient advance warning of changes in current laws could reduce these hardships and also assure that fishermen can pay back any bank loans they may have incurred. It is possible with forethought to minimize the hardship and costs of dislocation while still proceeding with firmness.

Over time, the small-scale fishery would fill the niche previously occupied by the small trawlers. The increased effort in the small-scale fishery would come from four sources:

- (1) Most of the 10% of the Bay's total fishing labor force which would be displaced if trawling were banned, would most probably join the small-scale fishing fleet.
- (2) New entrants from outside fishing would be attracted by the additional short-term profits that would be earned by the current small-scale fleet. Fishing incomes in the small-scale fleet are now roughly comparable to the opportunity wage in other activities, so any increase in the returns to labor and capital in small-scale fishing would likely attract new entrants from the agricultural sector as long as access to use most small-scale gears remains open.
- (3) Technological improvements would then follow. For example, when Indonesia banned all coastal trawling, gill-net fishermen switched to trammel nets and learned to use them for catching shrimp.
- (4) Continued population growth will continue to add to the small-scale fishing labor force. Assuming current rates of outmigration continue and non-fishing employment opportunities in the San Miguel Bay area remain limited, the natural rate of population growth in the Bay's fishing communities will remain approximately 2% annually. Consequently, within 35-40 years, the fishing population of San Miguel Bay will have doubled. This labor force growth can be expected regardless of action taken with respect to small trawlers.

The end result of this increased effort in the small-scale sector will be that, again, despite any efforts to regulate the large-scale fishery, fishermen will be earning no more than their opportunity wage which, unless development occurs in the Bicol, will remain low.

Limiting the effective effort of small trawlers of San Miguel Bay, without at the same time limiting expansion of effort in the small-scale fishery, thus essentially "buys time" for other sectors to take up the task of employment and income generation. The same limitation holds true regarding all the previously discussed management interventions and mechanisms in that to the extent that they limit effort in only part of the total fishery, they are also only partial or temporary solutions.

#### Incentives

The theoretical arguments for increasing labor opportunity cost as a means to reduce levels of fishing effort have been expressed by Munro and Chee (1980), Smith (1981) and Panayotou (1982). Bailey (1982a) has presented the need for this longer-term perspective for San Miguel Bay fisheries.

Because of the extreme difficulties and costs associated with controlling levels of effort in the fishery, these arguments are attractive and certainly correct if one takes a long-term perspective. The introduction of alternative income-generating activities that would supplement fishing household income should be a part of the San Miguel Bay fishery management plan regardless of what steps are taken to limit effort in the short term. Educational programs to lengthen the average number of years that children from fishing households spend in school and to diversify their skills can also assist in reducing the long-term dependency of such households upon fishing.

*But in the long-term we are all dead.*

It is often argued that improvements in marketing and processing are appropriate interventions to increase fishing household incomes. However, in cases of fully exploited resources, marketing improvements are a double-edged sword. To the extent that fishing households can actually participate in marketing and processing they will be able to earn part of the added value previously earned by others. However, to the extent that improvements in marketing result in higher prices at the beach, the more likely are the income benefits to be transitory, dissipated by new entrants attracted by the higher prices. Consequently, a heavy dependence upon marketing and processing improvements to the exclusion of attempts to regulate fishing effort must be avoided. This is not to suggest that marketing programs should be neglected. This report has earlier discussed oligopoly/oligopsony control of the fuel supply/processing activities in some locations and every encouragement should be given to female members of fishing households to undertake these activities themselves, perhaps as a group activity.

The complexity of the problems and solutions in a fishery such as that in San Miguel Bay suggest that concerted effort and attention should be directed to managing the fishery. Current levels of management interest extend little beyond collection of catch statistics. One might argue that the San Miguel Bay fisheries need not command much attention in the context of the whole Philippine economy, the Philippine fisheries or even the Bicol Region. However, the fisheries are significant in terms of annual value (P55 million), employment (5,600 fishermen) and as a source of supply of fish and shrimp. A fishery of this size should be able to support a management authority with a full-time professional staff and a representative council to address the management issues. The potential for generating significant resource rents and the need to solve prevailing inequities in income distribution suggest that the benefits should exceed the costs of undertaking such an approach. Moreover, with the relatively good database now available for San Miguel Bay, this fishery, if managed, could become an instructive example for fisheries elsewhere.

#### A MANAGEMENT INFRASTRUCTURE

Within the current institutional framework it is difficult, if not impossible to envision that common management objectives and means of achieving them can be agreed upon among the many agencies, institutions and communities presently involved in the San Miguel Bay fisheries. These interested parties include several national agencies, two provinces, six municipalities, and 46 fishing communities with 5,600 fishermen using diverse, often competing gears. Agreement would be especially difficult because at present there is no single forum where the many different opinions of these diverse groups can be given adequate hearing. This confused situation is characterized by

(1) national legislation that ignores locale-specific differences, (2) municipal ordinances that are often insufficient to regulate fishing activities within municipal waters and (3) petitions from small-scale fishermen seeking redress that bypass all intermediary authorities and are submitted directly to the President of the country.

One solution to this confusion that would be worth considering is the creation of a San Miguel Bay Fisheries Management Authority that would have responsibility for developing and implementing a management plan for the Bay in close collaboration with the various fishing communities that presently use the Bay. The Bicol River Basin Development Program (BRBDP), which to date has focused its work almost exclusively on irrigation infrastructure and agricultural community development, could also be considered as an institution for implementing management decisions regarding San Miguel Bay. However, the broad scope of this institution's mandate which covers all of the Bicol may not be area-specific enough, so a separate institution especially for San Miguel Bay may be necessary.

To assure local support for the management program, municipal and provincial officials and fishermen themselves (through elected representatives?) should be represented. The management authority could be organized as a council that would need to liaise with BFAR, the Philippine Coast Guard and Philippine Constabulary to assure enforcement of regulations that it passes. Proposed regulations of the Authority could be subject to review by national authorities (e.g., Ministry of Natural Resources) as is currently true of municipal ordinances that impact on fisheries. The council would require a supporting technical staff headed by a professional fisheries manager. The technical staff should consist of biologists, economists, statisticians and sociologists because each of these disciplinary perspectives will be necessary to management decisionmaking.

#### **Tasks of a San Miguel Bay Fisheries Management Authority**

Management planning and the management institution proposed for San Miguel Bay should address the following tasks (after Smith 1983):

1. *Evaluation of management costs and benefits.* This report outlines various management options for San Miguel Bay in a non-quantifiable way. With additional data and application of more rigorous systems analysis or simulation modelling techniques it should be possible to determine in a preliminary fashion the costs and benefits of various management options. Calculation of costs should include those expenses necessary to maintain the management infrastructure itself. A single management authority for the Bay is likely to be far more cost-effective than the current mix of national and municipal authorities.

2. *The establishment of an information system.* Allocation decisions cannot be made without the necessary database, and at the minimum the following time-series data should be collected (after Lampe 1980):

- catch by competing users
- effort (number of units of competing gear types, number of trips/year)
- catch composition and length-frequency data on major species
- prices by species
- costs and earnings of major gear types (and from this, incomes of competing users).

The first four variables above will allow determination of the total value of the fishery and the relative shares earned by each gear type or user. Alternatively this could be estimated from annual costs and earnings data by gear type obtained from private operators, who may need considerable persuasion to cooperate. There are advantages, however, to record-keeping and surveys in that they invite the involvement of competing users in the management process. Steps must be taken, of course, to assure the reliability of the data provided by these users. Nevertheless, regardless of the data collection method, cost data are necessary for evaluating the economic health of the fishery.

In addition, data collected should also cover:

- patterns of ownership among the various users to determine the degree of concentration, and
- opportunity costs of labor and capital since these two cost items must be included in the calculations of total costs to determine if any positive resource rents are being earned.

The information system and complementary research that might be considered for San Miguel Bay are more fully discussed in part B of this report. An immediate task that could be addressed is a revised definition for municipal fisheries in the Bay designed to separate small-scale non-trawl and large-scale trawl fisheries (i.e., "baby" trawlers). For example, a 20-hp engine size demarcation may be more appropriate than the current 3 GT distinction between commercial and municipal fisheries.

3. *Setting of objectives.* Alternative goals of management were fully discussed in the previous section and in Table 15. Setting of management objectives can best be accomplished with participation in the decisionmaking process by all interested parties, including small-scale fishermen.

4. *Selecting a mechanism for controlling access and use rights.* Alternatives identified in this study as worthy of consideration include licenses, restrictions on certain gear types, mesh sizes or on vessel sizes or power, closed areas or some combination of these. The choice of the most appropriate mechanism would depend upon the management objectives to be achieved. As part of this task, a system for transfer of use rights such as an open market or bidding for licenses, for example, needs to be considered. Licenses that are transferable on the open market appear to be a better system of assuring that positive resource rents are sustainable over the long term.

It is in this area of selecting and enforcing the management regulation(s) and mechanism(s) that the best-intentioned management schemes break down. Either an inappropriate mechanism which fails to limit effort adequately is selected or the regulations are not enforced. Total catch quotas, for example, have been found to be ineffective in some locations because they fail to limit expansion of the fleet and thus do not control effective effort; overcapitalization of the fishery still results (Gulland 1972). In an extreme case, the Pacific yellowfin tuna total catch quota in 1970 was taken in 2 1/2 months with many of the vessels lying idle the remainder of the year, thus representing considerable waste to the economy and lost resource rents (Joseph 1972).

5. *Monitoring and evaluation.* Needless to say, a continuous system of monitoring and evaluation to permit refinement and change of any management interventions is warranted by conditions of the fishery and fishing communities in San Miguel Bay. The bulk of the data necessary for this task should come from the information system described above, supplemented by inputs from fishermen and others obtained at regular meetings of the management authority.

A detailed discussion of how the suggested San Miguel Bay Fisheries Management Authority might operate is beyond the scope of this study and report. However, the brief outline of tasks above gives some idea of the dimension of the management task and its complexity.

It is worthwhile in this context to cite one example of a successful management system that has promise of success in Asia. The most comprehensive and effective coastal management system is in Japan where coastal and inland waters are under the management of fishing communities and cooperatives (Comitini 1976; Akimichi 1982). The fishing communities exercise jurisdiction over coastal waters to a distance of 26 miles (41.8 km) and within national guidelines make *all* the use and allocation decisions related to who can fish, where, when and with what kind of gear. The cooperative serves as a forum for the resolution of conflicts and cooperative leaders are highly respected in their communities. The keys to the success of these Japanese systems is not that they are based around cooperatives per se but rather that they have complete authority within their area of jurisdiction and they have involved a high degree of participation by the fishermen themselves. This is in marked contrast to the capture fisheries elsewhere in Asia, including San Miguel Bay, where there are hybrid systems of national and local jurisdiction and regulation but little participation by fishermen.

## CONCLUSION

A key element in any future management scheme for San Miguel Bay will be the provision for participation of users in the decisionmaking process. In the Philippines, fisheries regulations and authority tend to be centralized at national levels though there is great potential for municipal roles in certain cases. Locale-specific refinements are rare, however, and the total lack of fishermen involvement in planning and management has created a situation where enforcement is extremely difficult, if not impossible. The Japanese system of coastal fishing rights cited above indicates the potential for systems that include a prominent role for fishing communities and which could be considered for San Miguel Bay and other coastal and inland fisheries in the Philippines, although the exact form of the management authority need not be cooperatives per se.

Decentralizing authority in this fashion would require participation by fishermen themselves in those decisions related to choice of management objectives and interventions. To date, the majority of fishermen have had little option but to send occasional petitions to national authorities due to the lack of a local forum. There are many who argue that political decentralization is a necessary condition for economic development (e.g., Loehr and Powelson 1982) and this perspective is endorsed. Stated differently, the problem for the fishery is the gap that presently exists as elsewhere in the Philippines between economic and political levels of the society (Goodell 1982) and the absence of resource management institutions to narrow the gap. Indicative of the problem, for example, is the government's fuel tax structure, whereby diesel fuel is taxed at much lower rates than is regular gasoline. This national level tax has encouraged capital-intensive small trawlers in the San Miguel Bay and other similar fisheries, thus exaggerating the economic gaps within the fishery in the absence of any management institution that might have foreseen the effects and taken steps to ameliorate them.

The advantages and potential of participation by fishermen in the development and management process have been eloquently argued by Johannes (1981), Kent (1981), Bailey (1982c), and Thomson (1983). Similar arguments have been put forward by Friedmann (1981) for rural dwellers as a whole. These arguments for 'participatory democracy' are more than mere rhetoric; it is abundantly clear from the case of San Miguel Bay that centralized fisheries management lacks the necessary locale-specific refinements and support of fishermen themselves that are necessary ingredients of any effective management program.

Regardless of one's political views regarding control over natural resource use, there is a strong practical argument in favor of decentralization of authority over fisheries in the case of San Miguel Bay. Without fishermen participation, enforcement of management regulations will be extremely problematic as experience with current legislation has shown. Indeed, many of the problems presently existing in the San Miguel Bay fishery would be overcome if only current legislation were enforced. National authorities must ask themselves *why* enforcement is such a problem and whether it could not be more readily assured through participatory management of the fisheries by fishermen, among other interested parties.

These issues are limited neither to fisheries, nor to the Philippines; they are broad development issues facing much of the developing world today. The conclusions of a recent comprehensive study of rural organizations in the Philippines (Po 1980) are worth repeating here:

Development has increasingly become the concern of both government and peoples. Essentially, development entails the growth of societies into higher forms which allow the fulfillment of human needs and actualization of human potential for more and more people. Critical participation of people and their control over the conditions which determine their livelihood, thus, become the key to development.

Characterized by uneven development, most Third World countries, however, are crippled by, precisely, this lack of participation of the majority of their people in the political processes and social

opportunities and benefits. Primarily, therefore, efforts aimed at rural development through rural organizations should make up for this limitation by allowing the rural population greater control over their own organizations and greater participation in policy-making processes. Only in this way rural organizations begin to serve the interests of the rural masses and function as effective means for rural development through rural mobilization.

The above sentiments are equally applicable to the San Miguel Bay fisheries because the IFDR/ICLARM study has clearly shown that managing the Bay's resources will require some limitation of fishing effort, that is, some of the current users will be denied access. Failure to take this step will not only contribute to continued waste of resources, but will also exacerbate the already inequitable distribution of benefits from the fishery between the competing large-scale and small-scale sectors. Denying access to some present users is clearly a political decision because it affects the distribution of income from the fisheries. A decision of this nature, before it is taken and if it is to be abided by, requires the opportunity for expression of different, possibly opposing points of view. The best way of reaching this integration would be to set up a permanent body (e.g., involving fishermen representatives, the Bureau of Fisheries and Aquatic Resources and the municipalities concerned) with clear prerogatives and tasks related to setting management objectives, agreeing upon management interventions, and collecting the necessary information to make informed decisions.

In addition to the participatory dimensions discussed above, the success of a management program for a particular fishery such as in San Miguel Bay will depend in great measure upon the support of an information gathering and research activity to clarify management options and monitor the impact of management interventions.

## Part B. Research Options

A successful management program for any fishery cannot proceed without an information base. Biological, economic and sociological data are required not only to clarify current conditions in the fishery and fishing communities but also to monitor and evaluate the impact of any management intervention undertaken. A useful first step in considering the possible need for a management program is to undertake a multidisciplinary research study of the type conducted by IFDR and ICLARM in San Miguel Bay, which consisted of three components—biology, economics and sociology.

The purpose of this part of the report is to discuss the research data and methods that were used in this study and also to identify information requirements and research options for a continuing management program for San Miguel Bay.

### GENERAL ISSUES

Various categories of data are necessary for either an initial investigatory study of the type already conducted for San Miguel Bay or for an information acquisition system to support an ongoing management program. The two required data sets are not the same, however. For the initial investigatory study, a comprehensive and exhaustive information collection effort is needed to build up an initial data bank. These efforts should include collection of the following indicative information:

- *Previously published and unpublished research studies* on the fish stocks, fisheries and communities in question, including not only fisheries-specific research but also that related to other sectors, such as agriculture, upon which the fishing communities in the area may depend in part.
- *Secondary data* on the fish stocks, fisheries and communities in question. Historical data on exploratory fishing (yields per unit area), number of vessels by type, catch, catch composition and length-frequency of major species are particularly important, if available. Equally useful are historical data on prices, incomes, costs and earnings, population growth and migration, incomes and costs/earnings of other income-generating activities in the vicinity of the fishing communities.
- *Literature* on research on other fish stocks and fisheries similar to those being investigated. This is important because generalizations can often be drawn from the conclusions of others regarding similar environments (e.g., estuaries).
- *Information on past, current and proposed government programs* in the area. For example, lending agencies, such as rural banks, are often valuable sources of information on historical investment flow into the fisheries and on feasibility analysis of particular gear types or development projects. Past efforts at community organizing (e.g., cooperatives) should also be identified and evaluated in a preliminary fashion at this stage.

Only after the above set of information is collected and analyzed should the research team embark upon major efforts to collect new *primary data*. Stressing the above process may appear to some readers to be stating the obvious; it is done because all too frequently a regrettable tendency has been observed for fisheries researchers—both fisheries and social scientists—to rush hastily into

new surveys and primary data collection without first evaluating what is already known by others about the fisheries under investigation. The present IFDR/ICLARM research group was no exception; several errors in this respect were made.

The above point is more than an argument for a thorough research process; it has cost implications as well. Primary data collection is expensive. Multidisciplinary research of the scope undertaken for San Miguel Bay is particularly expensive. Funds for research are scarce and cost-effectiveness should be a concern not only for multidisciplinary research studies of the IFDR/ICLARM type but also for information systems that are established to support fisheries management programs. Costs are directly related to information requirements, which is why careful identification of the latter is so important.

Multidisciplinary investigation of tropical multispecies multigear fisheries is never simple. However, one does not necessarily need to develop overly sophisticated models *in the first instance* to improve one's understanding of a given fishery. The important key is to make clear statements about manageable objectives with an early plan of how these goals are to be obtained by listing data requirements including quantity and quality, data sources and analysis planned (Pauly and Smith 1982; Smith and Pauly 1982).

The complexity of multispecies multigear fisheries should not prevent one from beginning with manageable approaches to data collection and analysis long before sophisticated modelling approaches are applied (see also Sutinen et al. 1981). In fact, it will be some time before such methods are applicable for tropical multispecies fisheries and if researchers await these models, the damage to fisheries from overfishing and the losses due to overcapitalization and inequitable distribution of benefits will continue unabated.

Before fieldwork of the IFDR/ICLARM San Miguel Bay study was initiated, the importance of integrating the methodologies and findings of the various disciplines (or modules) involved in the study was recognized. Constructing a sophisticated bio-socioeconomic model of the fishery was not planned due to anticipated data limitations, but it was clear that the status of the fishery, its potential need for management and its potential for inclusion in area development planning had to be evaluated in the broadest terms. The 1977 and 1978 petitions to the President of the Philippines and other government officials from the small-scale fishermen of San Miguel Bay regarding the operation of trawlers, and the sensitive management issues implied, necessitated this multidisciplinary approach. The IFDR/ICLARM research goals were thus very much site related in contrast to studies conducted elsewhere on small-scale fisheries information needs which have focused primarily upon evaluation of alternative data collection methodologies (see for example ICMRD 1981 and Stevenson et al. 1982).

At the initiation of the study of San Miguel Bay, a detailed work plan was developed for each discipline and which included agreement on the following elements in order:

- statement on *objectives*;
- working *hypotheses*, as applicable;
- types of *analysis* to be performed to achieve objectives or test hypotheses;
- list of *data requirements*; and
- list of all potential *data sources*.

This anticipation of the research process in the context of research objectives also enabled exclusion from consideration of certain biological and oceanographic research that is normally conducted as a matter of course in studies of this nature, but which was thought to be irrelevant in this case, given the objectives established. Inevitably, changes (and mistakes) were made as the study progressed; still, these detailed work plans greatly assisted in identifying information requirements for the study and allowing integration of data collection among the three modules of the study. This integration helped avoid duplication of effort and keep data collection costs within reasonable bounds.



It must also be recognized that data such as those collected by the multidisciplinary San Miguel Bay study represent only the first step in developing a management program for a fishery. Observations over time are needed. Because of the political connotations of the competition among various gear types in the case of San Miguel Bay (i.e., small-scale gears vs. trawlers), fisheries decision-makers and local politicians were under extreme pressure to take immediate action, and they looked to the research project to provide them with recommendations. This was avoided because it was believed that the allocation decisions belong to administrators and politicians; instead management options have been outlined, assuming various objectives (e.g., economic efficiency, employment or equity), and the likely impact of each was discussed (see Part A of this report). There is a crucial need for monitoring fisheries over time. Monitoring is particularly important because short-term and long-term approaches to management are unlikely to be similar and the institutional framework for fisheries management will take time to evolve.

Early in 1980, discussions were held with Dr. Harlan Lampe of the University of Rhode Island regarding conceptual considerations for fisheries management programs. In his report to the Fishery Industry Development Council, Government of the Philippines (Lampe 1980), he enumerated the "minimum requisite (data) set to evaluate the economic and biological behavior of a fishery".

This set consists of:

- catch and effort data
- catch composition data
- costs and earnings data
- supply and price information.

Lampe's recommendations confirmed that the San Miguel Bay project was on the right track with its concentration on collecting the above data set plus sociological variables. Most importantly, of course, this data set could reasonably be collected within the financial limits of the project, and analysis of the data collected could be completed in a timely fashion to be of optimal use to the government agencies in the San Miguel Bay area with responsibility for regulating the fishery. At the inception of the project in late 1979, it was decided that this data set should cover a minimum period of 12 months to capture seasonal variation. In fact, the project eventually included data collected for a period of 24 months.

In addition to this biological and economic data set, sociological data needs were identified regarding the intricacies of sharing systems and their change over time, social relations in marketing, the role of women and children, the attitude of fishermen towards their resource and extent of and attitudes towards occupational and geographic mobility. The labor mobility issue was particularly important. If the Bay was overfished as alleged (Simpson 1978), it was crucial for managing the fishery and improving incomes of small-scale fishermen that this study examine the nature of the flow of human resources between small-scale fisheries and other sectors, and assess the potential of programs that seek to reduce the heavy dependence of fishing households on capture fisheries.

Maximum use was made of historical and secondary data to supplement the primary data collected by the project's three disciplines. Too often, these sources of data are rejected outright as being unreliable. Particularly for the biological analysis, such data, with modifications based on knowledge of how they were collected, were found to be extremely useful. In fact, the biologists' assessment of the status of the San Miguel Bay fisheries would have been very difficult without such information.

Following are some techniques and comments, grouped according to the three disciplines involved in the San Miguel Bay study. The data sources and sampling methodologies of the present study are summarized in Tables 18-20, while the corresponding data gathered in each research module are summarized in Tables 21-23. Further details on methodologies can be found in Pauly and Mines (1982), Smith and Mines (1982), and Bailey (1982a, 1982b). The San Miguel Bay multi-disciplinary study has shed considerable light on a complex fishery but it remains but the first step in initiating an active management and information program to monitor interventions in the Bay's fishery.

Table 18. San Miguel Bay Project: major data sources and sampling methodology of stock assessment module.

Phase		Duration	Data collected	Frequency	Sampling methodology	Sample size
I	a) Catch and effort	2 years	Catch, effort and catch/effort data for all gears	Continuous	— small-scale fishery: gear counts and beachside sampling of catch-per-trip data	Very large, i.e., giving c/f on daily basis for some, and on monthly basis for most gears
				Continuous	— trawl fishery: sampling on board trawlers, complemented with in-depth analysis of adjusted catch statistics	About 2 trips per month
	b) Length-frequency data	2 years	Length-frequency data on 15 species of fish	Continuous	Measurement of length-frequency samples on board trawlers	About 2,500 fish measured
II	Bathymetric survey	1 day	Present depth contours of San Miguel Bay	Once	Echosounding of San Miguel Bay with portable echosounder	Forty percent of the Bay's surface area was covered
III	Survey of previous literature and historical data	2 years	List of fish and general hydrography of San Miguel Bay. Reviews, estimates of effort and of catch/effort of trawlers. Previous catch composition and anecdotal information on changes in the Bay's fishery	Continuous	Scanning of all likely sources of primary and secondary data, including files containing unanalyzed data, theses, published and unpublished reports	n/a

Table 19. San Miguel Bay Project: data sources and sampling methodology of economics module.

Phase		Duration	Data collected	Frequency	Sampling methodology	Sample size
I	Household inventory	3 months	Assets and no. of fishermen per household; sources of financing for owned assets; gears used	Single visit per household in target community	Census of all households in target community	Established sample frame (430 households) for subsequent data collection
II	Landing survey	1 year	Ex-vessel prices of major species. Catch per vessel landing. Number of vessels/gear types landing	3 times weekly at each landing site in target communities	Data collected from all vessels landing through observation and personal interviews of fishermen, wives, and buyers	Varied depending upon number of vessels landing
III	Market price survey	1 year (concurrent with landing survey)	Prices of fresh and processed products in 4 markets	2-3 times weekly	Data collected from all sellers in each market, supplemented by secondary price data of government	Varied depending upon number of sellers in the markets
IV	Costs and earnings record keeping	1 month	Assets, investment costs, life of assets, age and educational level of fishermen, sharing system used	Single interview	20% purposive sample (see below) of fishing units in 2 target communities	64 fishing units

Continued

Tabla 19. Continued.

Phase	Duration	Data collected	Frequency	Sampling methodology	Sample size	
	1 year	Catch, operating costs, value of catch per trip/day. Repair and maintenance costs, sharing system modifications	Daily record keeping	20% purposive sample of respondents willing to cooperate	64 fishing units	
V	Middlemen and processors cost survey	2 months	Fixed and variable costs, estimated life of fixed assets, daily volume, cost of purchases and receipts, attitudinal data regarding ease of entry	Single recall interview	20-50% random sample of middlemen and processors in target communities	64 firms

Tabla 20. San Miguel Bay Project: data sources and sampling methodology of sociology module.

Phase	Duration	Data collected	Frequency	Sampling methodology	Sample size	
I	Community inventory	5 months	Infrastructure, social services population, no. of fishing households	Single visit to all fishing communities	Key informants interviewed; secondary data from municipalities	Established sample frame for Phase II
II	Socioeconomic survey	7 months	Household characteristics, assets, income, education, attitudes, role of women, shering systems, marketing practices, occupational and geographic mobility. Physical count of all gears in all communities	Single interview of fishing households	30% sample of fishing households in 22 out of 41 fishing communities; mix of purposive and random sampling	641
III	Participant observation	1-6 months	In-depth information on marketing practices, role of women and children, shering systems and kinship	"Live-in" in single community	Participant observation and in-depth interviews with key informants	n/a
		16 months	Occupational and geographic mobility, labor absorption capabilities of other non-fishing sectors	"Live-in" in selected communities	Participant observation and in-depth interviews with key informants	
IV	Geographic mobility study	6 months	Population growth and migration patterns		Examination of census population and migration data, including preliminary tabulations on municipal and barangay data from 1980 census	n/a

Table 21. Data collected by the stock assessment module.

Catch per effort (c/f) of major gears	High emphasis; data of stock-assessment module complemented with data from socioeconomics module of project
Historical data on fishery (catch, effort, c/f, miscellaneous data)	High emphasis on extensive search for old publications, unpublished manuscripts, theses and raw data
Total catch during period of investigation, by species groups and gears	High emphasis, but mainly based on effort and c/f data obtained for all modules of project
Total effort during period of investigation, by gears	High emphasis, but mainly based on gear counts and annual number of trips by gears, obtained from socioeconomics module of project
Length-frequency data	Low emphasis, about 2,500 fish (15 species) measured
Hydrographical and biological data on ecosystems (estuaries)	Low emphasis on collection of new data; a 1-day bathymetric survey was conducted
Fish taxonomy	Low emphasis; one list of scientific names compiled from the literature (i.e., records of occurrence in San Miguel Bay) and complemented by <i>ad hoc</i> collections

Table 22. Data collected by the economics module.

1. Capture sector	
Costs and earnings of major gears	Highest emphasis: daily record-keeping data collected over 12 months from 64 fishing units representing 6 major gear types
Inventory of fishing assets	Interview of all respondents keeping daily records; gear counts provided by sociology module
Catch and effort	Observations at landings for 1 year and separate record-keeping for 1 year
Income of boat owners and crew	Interview of all respondents keeping daily records; annual income based on sharing system used
Prices received by fishermen	Observations at landings 2-3 times weekly for 1 year
Opportunity costs of labor and capital	Collected for alternative occupations in fishing communities, supplemented by other publications and data collected by sociology module
2. Marketing sector	
Quantities purchased and sold	Low emphasis: single interview of middlemen and processors to collect data on previous day's activity only
Wholesale and retail prices	High emphasis: monitored prices of fresh and processed products for period of 1 year in nearby retail markets. Secondary price data used for more distant wholesale and retail markets
Marketing costs of wholesalers	Interviews of 33 processors (salting and drying) in 2 target communities
Marketing costs of retailers	Interviews of 31 retailers in 2 target retail markets
Market structure, conduct and performance	Low emphasis: from interview data
Economies of scale	Low emphasis: from interview data

Table 23. Data collected by the sociology module.

Community infrastructure, social services, and fishing population	Key informants in all fishing communities
Sociocultural (age, education, no. of family members, years fishing, no. of dependents, kinship involvement in fishing, material culture, mass media exposure, crew structure)	Survey of 30% of fishing households in 22 of 41 fishing communities; total of 641 households chosen randomly
Fishing and non-fishing assets	Survey of 30% of fishing households in 22 of 41 fishing communities; total of 641 households chosen randomly
Attitudes, beliefs and values	Survey and participant observation in selected communities
Attitudes and beliefs regarding fisheries resource and its exploitation	Survey and key informants. No folk-taxonomy data collected
Effort, income, personnel	Survey
Attitudes towards saving	Data collected in survey
Role of women and children	Survey and intensive participant observation
Sharing systems and ownership patterns	Survey and intensive participant observation
Marketing practices	Survey and intensive participant observation
Attitudes towards mobility	Survey and intensive participant observation
Occupational and geographic mobility	High emphasis given to examination of census and migration data
Labor absorption capacity of non-fishing sectors	High emphasis given to examination of possibilities in agriculture, aquaculture and cottage industries

## BIOLOGICAL ANALYSIS

The primary purpose of the biological analysis was to assess the status of the fish resources of the Bay; several data sources were considered and used or rejected.

### Stock assessment data

The stock assessment methods used in the present study were based on available data, particularly catch and length-frequency data. With such data alone, it was possible to generate all parameters necessary for a basic assessment of the state of the fish stock (see Pauly 1979b; Pauly and Marto-subroto 1980; Pauly and David 1981; and Pauly et al. in press for additional discussion and applications).

A cost-effective data acquisition system for assessment and management of tropical multi-species multigear fisheries has recently been proposed by ICLARM (Munro 1983). The system requires samples of the major species to be collected on a routine systematic basis. Fig. 14 shows how the system works. Additional data from the fishery, as shown in the lower left side of the figure, can be used to generate the same parameters, but are more expensive or unavailable in many cases. Other production modeling approaches based on mortality estimates have also been recently developed (Csirke and Caddy 1983).

Other techniques for estimation of fish abundance include acoustic surveys but they are expensive and of limited use. For those interested, however, FAO has recently produced a manual on fisheries acoustics (Johannesson and Mitson 1983).

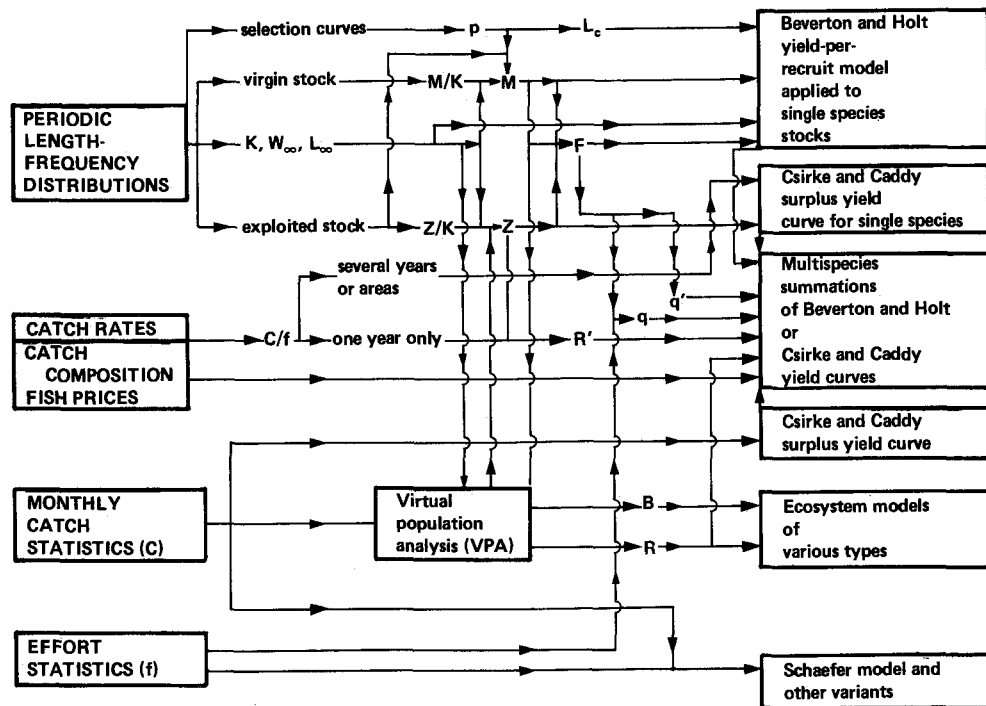

Fig. 14. Flow chart for biological and fishery parameter estimations leading to fishery assessments. Required inputs are shown in the boxes on the left-hand side; outputs on the right. Notation as follows: B = biomass; C = catch of a species by numbers or by weight; F = fishing mortality coefficient; K = growth coefficient;  $L_c$  = mean length at first capture;  $L_\infty$  = asymptotic length; M = natural coefficient; p = probability of retention of fish in a given length group; q = catchability;  $q'$  = catchability index; R = number of recruits;  $R'$  = index of recruitment;  $W_\infty$  = asymptotic weight; Z = total mortality coefficient; f = effort. (Adapted from Munro 1983).

#### Tagging-recapture data

Data from returns of tagged or marked fish (or shrimp) can in principle be used to obtain such information as movements and migration patterns, population sizes, mortality estimates and growth parameters. This methodology was not used in the IFDR/ICLARM study because of its anticipated high cost and low likelihood of success. Other researchers have given high emphasis to this technique and spent considerable effort to inform fishermen about the program (Stevenson 1981a, 1981b), but found it extremely difficult to obtain the number of returns (on a per-species basis) needed for parameter estimation. Using limited data could lead to biased mortality estimates when many fish may have been caught but not returned.

Major problems are still experienced with analyzing tagging data in temperate waters (Jones 1977). When assessing a multispecies tropical stock, it does not seem appropriate to rely on this methodology except when straightforward questions are to be answered, such as those pertaining to growth or local movements (Randall 1962).

#### Biological and oceanographic data

Very little emphasis was given in the San Miguel Bay project to the collection of biological data. However, the fish species occurring in trawl catches were recorded, which, combined with San Miguel Bay records from the taxonomic literature, enabled a compilation of list of fishes from San Miguel Bay containing 188 species, 28 of which were new records.

An exhaustive literature search was conducted of known biological characteristics of those fishes, allowing the grouping of species into various feeding guilds and building of a model of the trophic interrelationships in the Bay and hence a crude assessment of the potential impact of the

selective exploitation of various groups of species on the multispecies stock as a whole. Also, the list of fishes was divided into various groups depending on the reported extent of their euryhalinity, with the result that it was possible to characterize the San Miguel Bay fish fauna as a typical estuarine fauna, markedly separate from the hard bottom/reef fish fauna off the mouth of the Bay. The species list thus helped define the multispecies "unit stock" exploited by the San Miguel Bay fishery.

Slobodkin et al. (1980) discuss the theoretical background behind approaches based on compiling species lists, then inferring from those lists the (probable) properties of a given ecosystem. These approaches are highly recommended in all cases where a minimum of literature data (including occurrence in other ecosystems) is available on the species concerned, which is more often the case than generally thought (Simpson 1982).

Sufficient oceanographic and hydrological data were available for San Miguel Bay to provide a coherent picture of the Bay as an estuary. However, if such data as tidal amplitude, rainfall and salinity are absent, some measurements and estimates are needed to characterize the study area.

#### ECONOMIC ANALYSIS

Economic research for San Miguel Bay was concentrated in two of the most important of the 41 fishing communities and the research assistants lived in one of these communities for almost two years.

The major elements of the module's work included collection of costs and earnings and price data from sample respondents in the harvesting and marketing sectors. Experimentation with various methods of data collection and analysis was a necessary step to reach the objectives of assessing the economic health of the fishery.

##### Costs and earnings data

In the San Miguel Bay study, the highest emphasis was given to obtaining annual costs and earnings data from a sample of the major gears operating within the Bay.

Initially, the same approach was taken as has been applied elsewhere (e.g., Sutinen and Kolberg 1981); that is, through a combination of interview and observation at major landing sites, data were collected from various gears for each fishing trip (operating costs, catch, value of the catch, fishing location, age and education of major fishermen, sharing system used). This approach was abandoned, however, when it was realized that recurring samples of fishermen could not be monitored in this manner to obtain costs and earnings by fishing unit over time. For example, if a particular fisherman did not appear at the landing on a given day it was not known if he had fished with another fishing unit, used a different landing or simply not fished at all. Instead of trip interviews at landing sites, therefore, 12 months of record-keeping were used with a smaller sample (64 fishing units) of the major gears. This procedure produced a total of 11,248 daily trip records and was supplemented by an initial interview to obtain asset ownership and investment cost data. Landing observations were continued for one year to collect catch, effort and price data.

The conclusion that record-keeping is preferable to interview or observation techniques is consistent with the recommendations of Hussen and Sutinen (1981) who conducted similar work in Costa Rica. Confirming the appropriateness of this approach, Sutinen and Kolberg (1981) have used a general cost function to demonstrate the cost effectiveness of record-keeping over interview techniques when the number of variables to be measured is small ( $< 50$ ).

One may question record-keeping techniques because participants must often be selected non-randomly; this was the case in the San Miguel Bay studies though representativeness was sought. However, it is believed that it is better to obtain reliable data from a smaller sample of purposively chosen respondents than to collect poor quality data from a larger random sample.

### Prices received by fishermen

Landing site data, supplemented by secondary data from the Philippine Fish Marketing Authority, were used to determine ex-vessel fish prices in the San Miguel Bay project. Wholesale and retail prices for fresh and processed products were obtained 2-3 times per week from processing centers and two nearby provincial markets.

A study by the University of Rhode Island in Costa Rica made use of an imaginative *factura* system whereby receipts were used in triplicate by the primary buyers; one copy was given to the seller, one kept by the buyer and one given to the research team (Lampe 1980). On the *factura* were recorded quantities and prices by species, plus data on the fisherman's (seller's) fishing activity. Such a system would work well in situations where fish is sold by weight and where computational facilities exist for compiling and analyzing the huge amount of data that would be generated. In situations where fish is still sold unsorted by volume (rather than by weight) as in the Philippines, a fully satisfactory system for generating data on ex-vessel prices by species has yet to be devised. Consequently, estimates for price spreads and marketing margins in the San Miguel Bay study were rather crude approximations.

### Other data

To estimate the extent of resource rents or pure profits in a fishery, additional data beyond costs and earnings of individual fishermen are needed (Panayotou 1981). Resource rents represent that portion of the total value of the fishery that exceeds total costs. To compute resource rents, the following information is necessary:

- An estimate of *total costs*, including (1) all fixed and variable costs of fishermen, (2) opportunity costs of labor and capital and (3) any subsidies, but excluding (4) any government taxes. Subsidies represent a government cost and taxes, as on fuel in the case of San Miguel Bay, represent the taxing authority's share of the resource rents.
- An estimate of the *total value* of the fishery which includes the sum of (1) the value of the catch sold by fishermen, (2) the value of the catch taken for home consumption and (3) the excess or oligopoly/oligopsony profits that suppliers or middlemen may earn through their charges for inputs (e.g., fuel) or payment of reduced prices to fishermen.

The difference between total costs and total value as defined above represents the resource rent accruing to the fishermen. Resource rents may thus be divided, as they were in San Miguel Bay, between the fishermen, the government and suppliers/middlemen.

In contrast to price/kg data (see preceding subsection and detailed discussion in Yater et al. 1982) the fishermen's estimations of the value of catch sold and consumed at home are much more reliable. Consequently, this method of determining catch value seems better than the use of ex-vessel prices and catch data as long as the funds are available to support a record-keeping activity.

On the cost side, the estimation of opportunity costs of labor and capital was problematic in the San Miguel Bay study as it is in any study. More rigorous methods based on careful assessments of average labor earnings in other occupations and estimation of the marginal value product from labor use in fishing would have led to a more precise estimation of labor opportunity costs. Nevertheless, the most important point to stress is that these opportunity costs should not be omitted in the calculation of resource rents. Approaching the economic analysis from the point of resource rents rather than private profitability and returns on investment is also recommended for any economic component of any management-oriented research project.

Finally, a more rigorous analysis of the costs and benefits of the various management options for the Bay would be desirable under ideal circumstances. Such analysis would require time series data of the type collected by this project but would be needed for more than 12 months. It could become an integral part of any management scheme for San Miguel Bay.



## SOCIOLOGICAL ANALYSIS

The sociology researchers relied heavily upon three familiar techniques for primary data acquisition—household or fishermen surveys, key informants and participant observation. In addition, secondary data on population and migration were analyzed.

Studies conducted elsewhere often put exclusive emphasis on primary data and on perceptions of fishermen (see for example Pollnac 1981a, 1981b). This type of material is certainly important, but it should be supplemented with secondary data and measurement of constraints and actual behavior where possible. For example, the fishermen of San Miguel Bay showed very high interest across all age groups, educational levels and asset ownership in leaving fishing for another activity. While encouraging in the sense that it indicates receptivity to change, it was found that the actual potential for gainful employment in other activities was minimal. Examination of census and migration data showed what in fact the members of fishing households were doing in response to their desire to change from fishing—and that was “voting with their feet” and migrating to Manila. This was particularly true of young female members of fishing households. If the sociological surveys had concentrated solely upon attitudes and beliefs, this very important fact about population change in fishing communities and response to hardship in the fishing sector would have been missed.

In gathering primary data, attempts should be made to limit the number of variables covered. In the San Miguel Bay study, for example, the household survey was designed to serve part of the data needs of the economics, biology and sociology researchers; instead it should have been limited to basic sociocultural attributes, asset ownership and attitudinal questions. In particular, the fishing income and cost data that were collected through respondent recall during the survey were not of much use other than to roughly estimate the percentage of households exclusively dependent upon fishing.

## MONITORING THE FISHERY

While the research approaches outlined above emphasized the initial studies that must be conducted to establish a basic database on a given fishery, an important role of research in fishery management remains to be described. This role is that of *monitoring studies*, i.e., studies conducted on a continuing basis, to document among other things, the impact of management measures on the fishery, and to help finetune, or modify some of these measures.

Essentially, the methods used in monitoring studies will be a small subset of the wide variety of methods used in the initial study; also, the samples taken and analyses will be fewer and/or smaller in some cases than in the initial study. Certainly the number of variables monitored will be less.

The selection of methods will rely in part on the results of the initial study; the method found to provide most information at the least cost should be selected for continued application in the monitoring studies.

In the case of the San Miguel Bay study, which established which gears are most important in and most representative of each sector of the fishery, and which method provided most information on each gear, it would be appropriate to concentrate routine monitoring efforts on the motorized gill-netters as representative of the small-scale fishery and on the small trawlers as representative of the large-scale fishery. The *balao* fishery exploited by the mini trawlers should also be included, as should the liftnets if funds permit. These four gear types are recommended for inclusion because together they caught 72% of total catch by volume (70% by value) in 1980-81 and employ approximately 41% of the Bay's labor force.

It would be sufficient to select a few fishing units ( $\approx 20$  of each category) representative of these four types of gears, and to monitor, on a monthly basis, their catch (weight, value), catch composition (species, length-composition by species) and their costs and returns (including sharing agreement) to maintain a fair understanding of the basic forces affecting the San Miguel Bay fisheries.

The total number of these fishing units operating should be determined once per year to establish rates of entry and exit and ownership patterns.

Limiting the routine data collection to these items would allow for some research effort to be available for *special investigations*, conducted as the occasion arises (e.g., in conjunction with students collecting data for a thesis, or with specific problems arising in the fishery). Such special investigations could include, for example:

- (i) in-depth investigation of a given fish species (e.g., as done by Navaluna 1982 with the tiger-toothed croaker).
- (ii) in-depth investigations of a given gear (e.g., as done by Vakily 1982 with the small trawlers).
- (iii) investigations regarding fishermen's attitudes to the management regime, specific interventions undertaken and enforcement problems.
- (iv) modelling of the Bay ecosystem as a whole using, e.g., the ECOPATH model of Polovina and Ow (1983).
- (v) developing a bio-economic model of the Bay and its fisheries.

Tasks (iv) and (v), as in any other modelling exercise would themselves help generate new interesting topics for special investigations, because models of any system need comprehensive data, and generally help in identifying gaps in one's database on the system in question. As such models become refined they could become valuable 'predicters' of the impact of alternative management interventions.

#### COMMUNICATION OF RESULTS

A multidisciplinary study, such as the present investigation, produces results of interest not only to a research audience in the Philippines but also to interested biologists and social scientists around the world. Also to be informed are the diverse interest groups in the vicinity of San Miguel Bay and elsewhere. All parties need to be advised of research findings in a way appropriate for them.

Monitoring research, whether or not including special investigations must be reported upon in timely and readily understandable fashion. For this purpose a San Miguel Bay Fisheries Management Authority could issue a semi-regular Newsletter or leaflet series containing data on variables monitored continuously by the authority, e.g.,

- number of gears (by gear type operating in the Bay);
- input prices and selling prices of major species caught in the Bay;
- the value of major indices representative of the health of the stock (e.g., the catch per effort of the selected gears that are monitored on a continuous basis; length-frequency of important species).

Such a Newsletter would also include, obviously, items about legal and political aspects of the Bay's fishery, a continuing self-presentation of the Authority and of its mandate and role, as well as items about and from individual fishermen (e.g., interviews, letters, etc.). The Newsletter should be in the Bicol language, not English or Tagalog.

The research audience can be addressed through formal communications in reports and articles in the primary literature, as well as through informal popular or "Newsletter" type articles.

For example, the results of the present study consisted of 24 articles in five technical reports which were distributed worldwide. A comprehensive summary was published in the ICLARM Newsletter, reprinted by IFDR and ICLARM and subsequently translated into the Bicol and Tagalog languages. Some detailed results were presented in theses, while summaries of various aspects were presented at conferences and at seminars in the Bicol area and abroad. Press releases to the local and overseas press were also made.

The special interest groups who should also be informed of research results include fishermen, concerned fisheries agencies and other governmental bodies with jurisdiction over the fisheries under investigation.

Communication to these groups is more problematic than communication with other scientists and researchers for several reasons. The first problem facing fisheries researchers is that all too often no one is listening. Failure to integrate research findings with development planning is common, and the researcher often has to wait until the research is completed before being able to convince the fisheries planners and administrators of the usefulness of such integration. This was also the case with this study of San Miguel Bay fisheries because no cohesive management framework or administrative structure yet exists into which the study's findings could be injected.

#### INTEGRATION OF RESEARCH AND MANAGEMENT PLANNING

Research is seldom seen as part of the necessary continuing process of data collection and analysis required for rational management of fisheries. In most tropical countries, statistics collection efforts are concentrated upon catch and possibly prices, and exhibit a lack of appreciation of the value of management-oriented research. Researchers themselves often contribute to this problem when they concentrate on partial analyses, whether biological or socioeconomic, that stop short of evaluating management options.

Fisheries agencies usually expect researchers to come up with a list of recommendations on what should be done by way of followup. If the researcher is examining a narrow issue, such as vessel or gear efficiency, then recommendations for improvement may be appropriate. In the case of studies as broad as the IFDR/ICLARM San Miguel Bay study, however, where the major issues are those of potential overfishing, use rights and allocation, it is unreasonable to expect researchers to make explicit recommendations. This is because any action that redistributes income should be the result of a political process, a process that should not be preempted by the researcher.

#### Acknowledgements

We would like to express our appreciation to the United Nations University in Tokyo and the Philippine Council for Agriculture and Resources Research and Development in Los Baños which provided financial assistance towards the costs of the IFDR/ICLARM multidisciplinary study of the small-scale fisheries in San Miguel Bay. We would also like to thank all those researchers who contributed to this study: Greg Bañacia, Luz Yater, Amelia Esporas, Elma Villafuerte, Anita Villegas, Conner Bailey, Noli Navaluna, El Cinco, Michael Vakily, Francia Yater, Neri Supanga, Estrella Tulay, Dennis Pamulaklakin and Wilfrido Cruz.

The Philippine Fish Marketing Authority, the Bureau of Fisheries and Aquatic Resources, the National Census and Statistics Office, the Natural Resources Management Center, the Bicol River Basin Development Program and the Ministry of Natural Resources all provided valuable data and interpretations of various government policies and regulations.

Our greatest debt is to the fishermen and municipal officials of San Miguel Bay, particularly those in Castillo, Cabusao and Sabang, Calabanga. This project relied heavily upon their willingness to share data and insights with our researchers and without this cooperation we would never have been able to complete the study. Individual researchers owe debts of gratitude to numerous individuals who made their two-year stay in Castillo and Sabang comfortable and a 'home away from home'. To everyone who assisted us in our work may we say, *'maraming salamat po'*.

Finally, we would like to thank those colleagues, especially Conner Bailey, Jay Maclean and Richard Neal, who reviewed earlier drafts of this manuscript and provided valuable comments and suggestions. Nevertheless, the opinions expressed in this report are our own responsibility.

## References

- Abrera, A.S. 1976. Philippine poverty thresholds, p. 223-273. *In* M. Mangahas (ed.) *Measuring Philippine development: report of the social indicators project*. Development Academy of the Philippines, Manila.
- Akimichi, T. 1982. A brief note on the fishery management system in Japan. Paper presented at the FAO Workshop on Territorial Use Rights in Fisheries, December 1982, FAO, Rome.
- Alcala, A.C. 1981. Fish yield of coral reefs of Sumilon Island, Central Philippines: implications for coral reef resources management in the Philippines. *Nat. Res. Council. Philipp. Bull.* 36(1): 1-7.
- Alexander, P. 1982. *Sri Lankan fishermen: rural capitalism and peasant society*. Monographs on South Asia No. 7. The Australian National University, Canberra.
- Anderson, L.G. 1977. *The economics of fisheries management*. The Johns Hopkins University Press, Baltimore and London.
- Bailey, C., Editor. 1982a. *Small-scale fisheries of San Miguel Bay, Philippines: social aspects of production and marketing*. ICLARM Technical Reports 9, 57 p. Institute of Fisheries Development and Research, College of Fisheries, University of the Philippines in the Visayas, Quezon City, Philippines; International Center for Living Aquatic Resources Management, Manila, Philippines; and the United Nations University, Tokyo, Japan.
- Bailey, C. 1982b. *Small-scale fisheries of San Miguel Bay, Philippines: occupational and geographic mobility*. ICLARM Technical Reports 10, 57 p. Institute of Fisheries Development and Research, College of Fisheries, University of the Philippines in the Visayas, Quezon City, Philippines; International Center for Living Aquatic Resources Management, Manila, Philippines; and the United Nations University, Tokyo, Japan.
- Bailey, C. 1982c. *Access to and management of coastal marine resources: the fishing communities of San Miguel Bay, Philippines*. Paper presented at the CCSEAS/ISEAS Joint Seminar on Village Level Modernization, Livelihoods, Resources and Cultural Continuity, 21-24 June 1982, Singapore.
- Baranov, F.I. 1925. On the question of the dynamics of the fishing industry. *Byulleten Rybnogo Khozyaistva* 8: 7-11. (Translated from the Russian by W.E. Ricker with the assistance of N. Artin in 1945).
- Bell, F.W. and R.F. Fullenbaum. 1973. The American lobster fishery: economic analysis of alternative management strategies. *Mar. Fish. Rev.* 35: 1-6.
- Beverton, R.J.H. and S.J. Holt. 1956. *The theory of fishing*, p. 372-441. *In* M. Graham (ed.) *Sea fisheries: their investigation in the United Kingdom*. Edward Arnold, London.
- Bureau of Census and Statistics. 1939. *Census of the population*. Bureau of Census and Statistics, Manila.
- Bureau of Census and Statistics. 1948. *Census of the population*. Bureau of Census and Statistics, Manila.
- Bureau of Census and Statistics. 1960. *Census of the population*. Bureau of Census and Statistics, Manila.
- Cariño, B.V. 1979. Migration and regional development: the Bicol Region, p. 251-258. *In* R.J. Pryor (ed.) *Migration and development in Southeast Asia: a demographic perspective*. Oxford Univ. Press, Kuala Lumpur and New York.
- Castillo, G.T. 1979. *Beyond Manila: Philippine rural problems in perspective*. IDRC-116e. International Development Research Centre, Ottawa, Ontario, Canada.
- Christy, F.T. and A. Scott. 1965. *The commonwealth in ocean fisheries: some problems of growth and economical allocation*. The Johns Hopkins University Press, Baltimore and London.
- Comitini, S. 1976. Economic and legal aspects of Japanese fisheries regulation and control. *Wash. Law Rev.* 43: 179-196.
- Crutchfield, J.A. 1979. Economic and social implications of the main policy alternatives for controlling fishing effort. *J. Fish. Res. Board Can.* 36(7): 742-752.
- Csirke, J. and J.F. Caddy. 1983. Production modeling using mortality estimates. *Can. J. Fish. Aquat. Sci.* 40: 43-51.
- Drew, D.R., L.C. Wadhwa, H. Paul and C.H. Hsieh. 1975. *Bicol River Basin Development Program simulation model*. Summary of final report. United States Agency for International Development (USAID), Manila.
- Emmerson, D.K. 1980. *Rethinking artisanal fisheries development: Western concepts, Asian experiences*. World Bank Staff Working Paper No. 423, 97 p. The World Bank, Washington, D.C.
- FIDC. 1981. *Integrated fisheries development plan for the 1980s*. Volume 1. *Directions for Fisheries Development in the 1980's*. Fishery Industry Development Council, Manila.

- FIDC and TBAC. 1983. Consolidated report on the evaluation of the implementation of the *Biyayang Dagat* program. FIDC Technical Report Series I. 38 p. Fishery Industry Development Council, Quezon City and Technical Board for Agricultural Credit, Manila.
- Firth, R. 1966. Malay fishermen: their peasant economy (2nd ed. rev.). Archon, Hamden, Connecticut.
- Fischer, W. and P.J.P. Whitehead. 1974. FAO species identification sheets for fishing purposes. Eastern Indian Ocean (Fishing area 57) and Western Central Pacific (Fishing area 71).
- Friedmann, J. 1981. The active community: toward a political-territorial framework for rural development in Asia. *Econ. Dev. Cult. Change* 29(2): 235-261.
- Fullenbaum, R.F. and F.W. Bell. 1974. A simple bioeconomic fishery management model: a case study of the American lobster fishery. *Fish. Bull.* 72(1): 13-25.
- Garcia, S. 1983. Comment on the definitions of artisanal fisheries, p. 52-58. *In* Planning portfolio for potential participants: the stock assessment collaborative research support program. Univ. of Maryland, Chesapeake Biological Laboratory, Solomons, Maryland, U.S.A.
- Gittinger, J.P. 1972. Economic analysis of agricultural projects. A World Bank publication. The Johns Hopkins University Press, Baltimore and London.
- Goodell, G. 1982. Politics and development. *In* Chronicles of culture, published by The Rockford Institute. (As reprinted in *Dialogue* 59(1): 74-76. [1983].)
- Gordon, H.J. 1954. Economic theory of a common property resource: the fishery. *J. Polit. Econ.* 62: 124-142.
- Graham, M. 1935. Modern theory of exploiting a fishery, and application to North Sea trawling. *J. Cons., Cons. Int. Explor. Mer* 10(2): 264-274.
- Gulland, J.A. 1972. Fishery management and the needs of developing countries, p. 175-188. *In* B.J. Rothschild (ed.) *World fisheries policy: multidisciplinary views*. University of Washington Press, Seattle and London.
- Gulland, J.A. 1974. *The management of marine fisheries*. University of Washington Press, Seattle.
- Gulland, J.A. 1982. Long-term potential effects from management of the fish resources of the North Atlantic. *J. Cons., Cons. Int. Explor. Mer* 40(1): 8-16.
- Hardin, G. 1968. The tragedy of the commons. *Science* 162(3859): 1243-1248.
- Henderson, J.V. and M. Tugwell. 1979. Exploitation of the lobster fishery: some empirical results. *J. Environ. Econ. Manage.* 6: 287-296.
- Herre, A.W. 1953. Checklist of Philippine fishes. U.S. Fish. Wildl. Serv. Rep. 20. 977 p. Washington, D.C.
- Holazo, V.F.V. 1982. Comparative efficiency of gasoline, kerosene and diesel engines for Philippine bancas, p. 65-69. *In* R.C. May, J.R. Smith and D.B. Thomson (eds.) *Appropriate technology for alternative energy sources in fisheries*. ICLARM Conference Proceedings 8, 215 p. Asian Development Bank and International Center for Living Aquatic Resources Management, Manila, Philippines.
- Hussen, A. and J.G. Sutinen. 1981. An economic analysis of fisheries production in the Gulf of Nicoya, Costa Rica, p. 205-227. *In* *Small-scale fisheries in Central America: acquiring information for decisionmaking*. International Center for Marine Resource Development, University of Rhode Island, Kingston.
- ICMRD. 1981. *Small-scale fisheries in Central America: acquiring information for decisionmaking*. International Center for Marine Resource Development, University of Rhode Island, Kingston.
- Illo, J.F.I. and F. Lynch. 1974a. Who get the jobs—the old or the educated? Education and unemployment in the Bicol River Basin. SSRU Research Project Series No. 8. Social Science Research Unit, Naga City.
- Illo, J.F. and F. Lynch. 1974b. The unemployed and the underemployed in the Bicol River Basin. SSRU Research Report Series No. 10. Social Science Research Unit, Naga City.
- Johannes, R.E. 1981. Working with fishermen to improve coastal tropical fisheries and resource management. *Bull. Mar. Sci.* 31(3): 673-680.
- Johannesson, K.A. and R.B. Mitson. 1983. *Fisheries acoustics: a practical manual for aquatic biomass estimation*. FAO Fish. Tech. Pap. 240. 249 p.
- Jones, R. 1976. Mesh size regulation in the demersal fisheries of the South China Sea. SCS/76/WP/34. 75 p. South China Sea Fisheries Development and Coordinating Programme, Manila, Philippines.
- Jones, R. 1977. Tagging: theoretical methods and practical difficulties, p. 46-66. *In* J.A. Gulland (ed.) *Fish population dynamics*. John Wiley and Sons, New York.
- Joseph, J. 1972. International arrangements for the management of tuna: a world resource, p. 90-120. *In* B.J. Rothschild (ed.) *World fisheries policy: multidisciplinary views*. University of Washington Press, Seattle and London.

- Kent, G. 1981. Community-based development planning. *Third World Planning Review* 3(3): 314-326.
- Kim, Y. 1972. Net internal migration in the Philippines, 1960-1970. Technical Paper No. 2. Bureau of Census and Statistics, Manila.
- Lampe, H. 1980. Conceptual considerations for fisheries management programs. Report prepared for the Fishery Industry Development Council (FIDC), Ministry of Natural Resources, Manila. Available from International Center for Living Aquatic Resources Management, Manila.
- Larkin, P. 1982. Directions for future research in tropical multispecies fisheries, p. 309-328. *In* D. Pauly and G. Murphy (eds.) *Theory and management of tropical fisheries*. ICLARM Conference Proceedings 9, 360 p. International Center for Living Aquatic Resources Management, Manila and Division of Fisheries Research, Commonwealth Scientific and Industrial Research Organisation, Cronulla, Australia.
- Lawson, R.M. 1978. Incompatibilities and conflicts in fisheries planning in Southeast Asia. *Southeast Asian J. Soc. Sci.* 6(1-2): 115-136.
- Legasto, R.M., C.M. del Mundo and K.E. Carpenter. 1975. On the hydrobiological and socio-economic surveys of San Miguel Bay for the proposed fish nurseries/reservations. *Philipp. J. Fish.* 13(2): 205-246.
- Librero, A.R., R.F. Catalla and R.M. Fabro. 1982. Socioeconomic conditions of small-scale fisheries in the Philippines. *Fish. Res. J. Philipp.* 7(1): 1-17.
- Loehr, W. and J. Powelson. 1982. *The economics of development and distribution*. Harcourt Brace Jovanovich, New York. 436 p.
- Macleay, J.L. 1980. The ICLARM-IFDR multidisciplinary study of small-scale fisheries of San Miguel Bay, Philippines. *ICLARM Newsletter* 3(2): 14-16.
- Mariano, D.L. 1981. The plight of Manila Bay's "baby trawlers". *Observer*. 29: 21-23.
- Marshall, N. 1979. Fishery yields of coral reefs and adjacent shallow water environments, p. 103-109. *In* S.B. Saila and P.M. Roedel (eds.) *Stock assessment for tropical small-scale fisheries*. International Center for Marine Resource Development, University of Rhode Island, Kingston.
- Meany, F.T. 1979. Limited entry in the Western Australian rock lobster and prawn fisheries: an economic evaluation. *J. Fish. Res. Board Can.* 36(7): 789-798.
- Meemeskul, Y. 1979. Optimum mesh size for the trawl fishery in the Gulf of Thailand. Paper presented at the Indo-Pacific Fishery Commission Standing Committee on Resources Research and Development, 2nd Session, 3-8 December 1979, Hongkong. IPFC: RRD/11/79/Inf. 13.
- Mines, A.N., D. Pauly, N.A. Navaluna and J.M. Vakily. 1982. The physical environment, p. 5-14. *In* D. Pauly and A.N. Mines (eds.) *Small-scale fisheries of San Miguel Bay, Philippines: biology and stock assessment*. ICLARM Technical Reports 7, 124 p. Institute of Fisheries Development and Research, College of Fisheries, University of the Philippines in the Visayas, Quezon City, Philippines; International Center for Living Aquatic Resources Management, Manila, Philippines; and the United Nations University, Tokyo, Japan.
- Munro, J.L. 1983. A cost-effective data acquisition system for assessment and management of tropical multispecies, multigear fisheries. *Fishbyte (Newsletter of the Network of Tropical Fisheries Scientists)* 1(1): 7-12.
- Munro, G.R. and K-L. Chee. 1980. *The economics of fishing and the developing world: a Malaysian case study*. Penerbit Universiti Sains Malaysia, Pulau Piñang, Malaysia. 139 p.
- Nahan, M.D. 1982. *Bionomic investigation of the Malaysian large-scale fishing sector: a case study of Kedah/perlis*. The Australian National University, Canberra, Australia. Ph.D. dissertation.
- Navaluna, N.A. 1982. Morphometrics, biology and population dynamics of the croaker fish, *Otolithes ruber*, p. 38-55. *In* D. Pauly and A.N. Mines (eds.) *Small-scale fisheries of San Miguel Bay: biology and stock assessment*. ICLARM Technical Reports 7, 124 p. Institute of Fisheries Development and Research, College of Fisheries, University of the Philippines in the Visayas, Quezon City, Philippines; International Center for Living Aquatic Resources Management, Manila, Philippines; and the United Nations University, Tokyo, Japan.
- NCSO. 1970a. *Census of population and housing, Camarines Norte*. National Census and Statistics Office, Manila.
- NCSO. 1970b. *Census of population and housing, Camarines Sur*. National Census and Statistics Office, Manila.
- NCSO. 1971a. *Census of agriculture, Camarines Norte. Vol. 1, Final Report*. National Census and Statistics Office, Manila.
- NCSO. 1971b. *Census of agriculture, Camarines Sur. Vol. 1, Final Report*. National Census and Statistics Office, Manila.
- NCSO. 1975a. *Integrated census of the population and its economic activities. Vol. 1. Population, Camarines Norte*. National Census and Statistics Office, Manila.

- NCSO. 1975b. Integrated census of the population and its economic activities. Vol. 1. Population, Camarines Sur. National Census and Statistics Office, Manila.
- NCSO. 1981. Unpublished preliminary tabulations of the 1980 census. National Census and Statistics Office, Manila.
- NEDA. 1975. Statistical Yearbook, 1975. National Economic and Development Authority, Manila.
- NEDA. 1982. Philippine Statistical Yearbook. National Economic and Development Authority, Manila.
- Panayotou, T. 1981. Cost structure and profitability of small-scale fishing operations: methodological framework. Paper presented to the IDRC small-scale fisheries workshop, May 1981. Singapore.
- Panayotou, T. 1982. Management concepts for small-scale fisheries: economic and social aspects. FAO Fisheries Technical Paper No. 228, Food and Agriculture Organization of the United Nations, Rome.
- Pauly, D. 1979a. Theory and management of tropical multispecies stocks: a review with emphasis on the Southeast Asian demersal fisheries. ICLARM Studies and Reviews 1, 35 p. International Center for Living Aquatic Resources Management, Manila.
- Pauly, D. 1979b. A new methodology for rapidly acquiring basic information on tropical fish stocks: growth, mortality and stock recruitment relationships, p. 154-172. In S.B. Saila and P.M. Roedel (eds.) Stock assessment for tropical small-scale fisheries. International Center for Marine Resource Development, University of Rhode Island, Kingston.
- Pauly, D. 1980. A selection of simple methods for the assessment of tropical fisheries. FAO Fish. Circ. No. 729. 54 p.
- Pauly, D. 1982. History and status of the San Miguel Bay fisheries, p. 95-124. In D. Pauly and A.N. Mines (eds.) Small-scale fisheries of San Miguel Bay, Philippines: biology and stock assessment. ICLARM Technical Reports 7, 124 p. Institute of Fisheries Development and Research, College of Fisheries, University of the Philippines in the Visayas, Quezon City, Philippines; International Center for Living Aquatic Resources Management, Manila, Philippines; and the United Nations University, Tokyo, Japan.
- Pauly, D. and P. Martosubroto. 1980. The population dynamics of *Nemipterus marginatus* off Western Kalimantan, South China Sea. J. Fish Biol. 17: 263-273.
- Pauly, D. and N. David. 1981. ELEFAN I, a BASIC program for the objective extraction of growth parameters from length-frequency data. Meeresforschung 28(4): 205-211.
- Pauly, D., J. Ingles and R.A. Neal. Application to shrimp stocks of objective methods for the estimation of growth, mortality and recruitment-related parameters from length-frequency data (ELEFAN I and II). NOAA/FAO Workshop on the scientific basis for the management of penaeid shrimps, November 1981. Florida. (In press).
- Pauly, D. and A.N. Mines, Editors. 1982. Small-scale fisheries of San Miguel Bay, Philippines: biology and stock assessment. ICLARM Technical Reports 7, 124 p. Institute of Fisheries Development and Research, College of Fisheries, University of the Philippines in the Visayas, Quezon City, Philippines; International Center for Living Aquatic Resources Management, Manila, Philippines; and the United Nations University, Tokyo, Japan.
- Pauly, D. and G.I. Murphy, Editors. 1982. Theory and management of tropical fisheries. ICLARM Conference Proceedings 9, 360 p. International Center for Living Aquatic Resources Management, Manila, Philippines and Division of Fisheries Research, Commonwealth Scientific and Industrial Research Organisation, Cronulla, Australia.
- Pauly, D. and I.R. Smith. 1982. The research process and communication of results: lessons learned from a multi-disciplinary analysis of a tropical small-scale fishery. Paper presented to the ACMRR Working Party on the Management of Resources in Near-Shore Waters, 28 February-4 March 1983, Rome, Italy.
- Pearse, P.H. 1980. Regulation of fishing effort. FAO Fish. Tech. Pap. No. 197. 82 p.
- Pearse, P.H. 1982. Approaches to economic management of fisheries. Paper presented for the Seminario Internacional Sobre la Administracion de las Pesquerias Chilenas, Santiago, Chile, 29 July 1982.
- Piansay, E., Z. de la Cruz and M. Lizarondo. 1979. Marketing operations of sustenance fishermen in Camarines Sur. Agricultural Marketing Report Vol. 1, No. 1. 69 p. Bureau of Agricultural Economics, Ministry of Agriculture, Quezon City.
- Po, B. 1980. Rural organizations and rural development: a documentary study, p. 1-123. In M. S. Fernandez (ed.) Rural organization in the Philippines. IPC Papers 13. Institute of Philippine Culture, Ateneo de Manila University.
- Pollnac, R.B. 1981a. Social and cultural aspects of survey of small-scale fishermen, p. 93-98. In Small-scale fisheries in Central America: acquiring information for decisionmaking. International Center for Marine Resource Development, University of Rhode Island, Kingston.

- Pollnac, R.B. 1981b. Anthropological surveys of the capture sector—Costa Rica, p. 99-103. *In* Small-scale fisheries in the Central America: acquiring information for decisionmaking. International Center for Marine Resource Development, University of Rhode Island, Kingston.
- Polovina, J.J. and M.D. Ow. 1983. ECOPATH: A user's manual and program listings. Southeast Fisheries Center, NMFS, Administrative Report H-83-23. Honolulu, Hawaii.
- Randall, J.E. 1962. Tagging reef fishes in the Virgin Islands. *Proc. Gulf Caribb. Fish. Inst.* 14: 201-241.
- Rettig, R.B. and J.J.C. Ginter, Editors. 1978. Limited entry as a fishery management tool. A Washington Sea Grant publication. University of Washington Press, Seattle and Washington.
- Ricker, W.E. 1975. Computation and interpretation of biological statistics of fish population. *Bull. Fish. Res. Board Can.* 191. 382 p.
- Roco, S.S. Jr. 1980. Education in Bicol: beyond reach of the rural poor. Final report submitted to the Ministry of Education and Culture, Region V. Naga City, Camarines Sur.
- Rondinelli, D.A. 1980. Spatial analysis for regional development: a case study of the Bicol River Basin of the Philippines. *Resource Systems Theory and Methodology Series, No. 2.* 45 p. The United Nations University, Tokyo.
- Saeger, J. 1981. Do trawling bans work in tropical waters? *ICLARM Newsletter* 4(1): 3-4.
- Saila, S.B. 1975. Some aspects of fish production and cropping in estuarine systems, p. 473-493. *In* L.E. Cronin (ed.) *Estuarine research. Vol. 1 (Chemistry, Biology and the Estuarine System)* Academic Press, New York. 738 p.
- Samson, E.D. 1982. National marine interests in fisheries in Southeast Asia. Draft chapter for *Marine Policy in Southeast Asia*, a publication of the East-West Center. Draft chapter published in advance by the Fishery Industry Development Council, Quezon City, Philippines.
- Sardjono, I. 1980. Trawlers banned in Indonesia. *ICLARM Newsletter* 3(4): 3.
- Schaefer, M.B. 1954. Some aspects of the dynamics of populations important to the management of the commercial marine fisheries. *Bull. Inter-Amer. Trop. Tuna Comm.* 1(2): 27-56.
- Scott, A.D. 1955. The fishery: the objectives of sole ownership. *J. Polit. Econ.* 63: 116-124.
- Simpson, A. 1978. Report of the BFAR/SCS Workshop on the fishery resources of the Pacific Coast of the Philippines. South China Sea Fisheries Development and Coordinating Programme, SCS/GEN/78/19. 48 p. Manila.
- Simpson, A.C. 1982. A review of the database on tropical multispecies stocks in the Southeast Asian region, p. 5-32. *In* Pauly, D. and G.I. Murphy (eds.) *Theory and management of tropical fisheries.* ICLARM Conference Proceedings 9, 360 p. International Center for Living Aquatic Resources Management, Manila, Philippines and Division of Fisheries Research, Commonwealth Scientific and Industrial Research Organisation, Cronulla, Australia.
- Sinoda, M., S.M. Tan, Y. Watanabe and Y. Meemeskul. 1979. A method for estimating the best cod-end mesh size in the South China Sea area. *Bull. Choshi Mar. Lab. China Univ.* 11: 65-80.
- Slobodkin, L.B., D.B. Botkin, B. Maguire, Jr., B. Moore III and H. Morowitz. 1980. On the epistemology of ecosystem analysis, p. 497-507. *In* V.S. Kennedy (ed.) *Estuarine perspectives.* Academic Press, New York.
- Smith, I.R. 1979. A research framework for traditional fisheries. *ICLARM Studies and Reviews* 2, 40 p. International Center for Living Aquatic Resources Management, Manila.
- Smith, I.R. 1980. Traditional fisheries development in the Philippines, p. 1135-1140. *In* J.I. Furtado (ed.) *Tropical ecology and development.* The International Society of Tropical Ecology, Universiti Malaya, Kuala Lumpur.
- Smith, I.R. 1981. Improving fishing incomes when resources are over-fished. *Mar. Pol.* 5(1): 17-22.
- Smith, I.R. 1983. Mismanagement of inland fisheries and some corrective measures, p. 88-100. *In* T. Petr (ed.) *Summary Report and Selected Papers presented at the IPFC Workshop on Inland Fisheries for Planners.* FAO Fish. Rep. No. 288.
- Smith, I.R. and A.N. Mines, Editors. 1982. Small-scale fisheries of San Miguel Bay, Philippines: economics of production and marketing. *ICLARM Technical Reports* 8, 143 p. Institute of Fisheries Development and Research, College of Fisheries, University of the Philippines in the Visayas, Quezon City, Philippines; International Center for Living Aquatic Resources Management, Manila, Philippines; and the United Nations University, Tokyo, Japan.
- Smith, I.R. and D. Pauly. 1982. Simple methods for the multidisciplinary investigation of tropical multispecies multigear fisheries. Paper presented at the Sea Grant Seminar and Workshop on Coastal Living Resources in Malaysia, 25-28 May 1982. Universiti Pertanian Malaysia, Kuala Trengganu, Malaysia. MS. 45 p.
- Smith, I.R., M.Y. Puzon, C.N. Vidal-Libunao. 1980. Philippine municipal fisheries: resources, technology and socioeconomics. *ICLARM Studies and Reviews* 4, 87 p. International Center for Living Aquatic Resources Management, Manila and the Fishery Industry Development Council, Manila.



- Poehr, A. 1980. Protein from the sea: technological change in Philippine capture fisheries. *Ethnology Monographs* No. 3. 224 p. Department of Anthropology, University of Pittsburgh, Pennsylvania.
- Squire, L. and H.G. van der Tak. 1975. Economic analysis of projects. A World Bank research publication. The Johns Hopkins University Press, Baltimore and London.
- Stevenson, D.K. 1981a. Assessment survey—Costa Rica, p. 45-65. *In* Small-scale fisheries in Central America: acquiring information for decisionmaking. International Center for Marine Resource Development, University of Rhode Island, Kingston.
- Stevenson, D.K. 1981b. Assessment of fishery resources—Gulf of Nicoya, Costa Rica, p. 187-203. *In* Small-scale fisheries in Central America: acquiring information for decisionmaking. International Center for Marine Resource Development, University of Rhode Island, Kingston.
- Stevenson, D., R. Pollnac and P. Logan. 1982. A guide for the small-scale fishery administrator: information from the harvest sector. International Center for Marine Resource Development, University of Rhode Island, Kingston.
- Strand, I.E., Jr. and V.J. Norton. 1980. Some advantages of landings taxes in fishery management, p. 411-417. *In* J.H. Grover (ed.) Allocation of fishery resources. Proceedings of the Technical Consultation on Allocation of Fishery Resources, Vichy, France, 20-23 April 1980. Published by Auburn University by arrangement with FAO in cooperation with the American Fisheries Society.
- Sturgess, N.H. and T.F. Meany, Editors. 1982. Policy and practice in fisheries management. Dept. of Primary Industry. Australian Govt. Publishing Service, Canberra.
- Supanga, N. and I.R. Smith. 1982. Costs and returns of stationary gears, p. 45-60. *In* I.R. Smith and A.N. Mines (eds.) Small-scale fisheries of San Miguel Bay, Philippines: economics of production and marketing. ICLARM Technical Reports 8, 143 p. Institute of Fisheries Development and Research, College of Fisheries, University of the Philippines in the Visayas, Quezon City, Philippines; International Center for Living Aquatic Resources Management, Manila, Philippines; and the United Nations University, Tokyo, Japan.
- Sutinen, J.G. and W.C. Kolberg. 1981. Economic surveys of the capture sector—Costa Rica, p. 67-92. *In* Small-scale fisheries in Central America: acquiring information for decisionmaking. International Center for Marine Resource Development, University of Rhode Island, Kingston.
- Sutinen, J.G., R.B. Pollnac and D.K. Stevenson. 1981. Information acquisition: some conclusions and recommendations, p. 595-602. *In* Small-scale fisheries in Central America: acquiring information for decisionmaking. International Center for Marine Resource Development, University of Rhode Island, Kingston.
- Szanton, M.C.B. 1972. A right to survive: subsistence marketing in a lowland Philippine town. The Pennsylvania State University Press, University Park and London.
- Thomson, D. 1983. Fishermen and fisheries management. Paper prepared for the Expert Consultation on the Regulation of Fishing Effort (Fishing Mortality), 17-26 January 1983, Rome, Italy. MS. 29 p.
- Toh, J.H. 1980. A case study in Camarines Norte area fishing cooperative in the Philippines, p. 609-631. *In* Proceedings Indo-Pacific Fishery Commission 19th Session, Kyoto, Japan. Section III. Symposium on the development and management of small-scale fisheries. FAO, Bangkok.
- Umali, A.F. 1932. The Japanese beam trawl used in Philippine waters. *Philipp. J. Sci.* 48(3): 389-410.
- Umali, A.F. 1937. The fishery industries of San Miguel Bay, *Philipp. J. Sci.* 63: 227-258.
- USAID. 1980. Country Development Strategy Statement, FY 1982, Philippines. United States Agency for International Development, Manila, Philippines.
- Vakily, J.M. 1982. Catch and effort in the trawl fishery, p. 65-94. *In* D. Pauly and A.N. Mines (eds.) Small-scale fisheries of San Miguel Bay, Philippines: biology and stock assessment. ICLARM Technical Reports 7, 124 p. Institute of Fisheries Development and Research, College of Fisheries, University of the Philippines in the Visayas, Quezon City, Philippines; International Center for Living Aquatic Resources Management, Manila, Philippines; and the United Nations University, Tokyo, Japan.
- Van Cleve, R. 1978. Factors determining the maximum possible fish catch, p. 225-260. *In* New protein foods. Vol. 3. Academic Press, New York.
- Warfel, H.E. and P.R. Manacop. 1950. Otter trawl explorations in Philippine waters. Research report No. 25. 49 p. Fish and Wildlife Service, U.S. Dept. of Interior. Washington, D.C.
- Yater, F., A.E. Esporas and I.R. Smith. 1982. Economic aspects of processing and marketing, p. 104-129. *In* I.R. Smith and A.N. Mines (eds.) Small-scale fisheries of San Miguel Bay, Philippines: economics of production and marketing. ICLARM Technical Reports 8, 143 p. Institute of Fisheries Development and Research, College of Fisheries, University of the Philippines in the Visayas, Quezon City, Philippines; International Center for Living Aquatic Resources Management, Manila, Philippines; and the United Nations University, Tokyo, Japan.

**Appendix A. Fisheries Administrative Order No. 136 (series of 1982):  
Establishing a Closed Season of Five (5) Years for the  
Operation of Commercial Fishing Boats in San Miguel Bay**

**Republic of the Philippines  
MINISTRY OF  
NATURAL RESOURCES**

**FISHERIES ADMINISTRATIVE  
ORDER NO. 136  
Series of 1982**

1982-02-23

**Subject: Establishing a closed season of five (5) years for the operation  
of commercial fishing boats in San Miguel Bay**

Pursuant to the provisions of Sections 4 and 7 of Presidential Decree No. 704, as amended, otherwise known as "Fisheries Decree of 1975," and Section 1 of Presidential Decree No. 1015 the following rules and regulations are hereby promulgated for the protection and conservation of fisheries and aquatic resources in San Miguel Bay.

**SECTION 1. Definition** — For the purpose of this Administrative Order, the following term shall mean:

- (a) **San Miguel Bay** — a body of water located in the Southeastern part of Luzon and bounded in the West by the coastlines of the Province of Camarines Norte, and on the South and East by the coastlines of the Province of Camarines Sur and enclosed in the North by an imaginary straight line drawn from Culasi Pt. and Siruma Island.

**SEC. 2. Prohibition** — It shall be unlawful during the five-year closed season established herein from the effectivity of this Order, for any person, partnership, association, cooperative, institution or corporation to operate all commercial fishing boats of more than three (3) gross tons in San Miguel Bay.

**SEC. 3. Penal Clause.** — Violation of the foregoing prohibition shall subject the offender to a fine of not less than Five Hundred Pesos (P500.00) but not more than Five Thousand Pesos (P5,000.00) or imprisonment from six (6) months to four (4) years or both such fine and imprisonment, in the discretion of the Court; Provided, That the Director of Fisheries and Aquatic Resources is hereby empowered to impose upon the offender an administrative fine of not more than Five Thousand Pesos (P5,000.00) including the confiscation of the gear and all the fishing paraphernalia used therein.

**SEC. 4. Repealing Clause.** — All existing administrative orders, rules and regulations or parts thereof which are inconsistent with the provisions of this Order are hereby repealed or amended accordingly.

**SEC. 5. Effectivity.** — This Order shall take effect fifteen (15) days after its publication in the Official Gazette and/or in two (2) newspapers of general circulation.

**TEODORO Q. PEÑA**  
Minister of Natural Resources

**RECOMMENDED BY:**

**FELIX R. GONZALES**  
Director  
Bureau of Fisheries and  
Aquatic Resources  
DILIMAN, QUEZON CITY

**Appendix B: Estimation of Trawler Mesh Size that would Optimize Yield Per Recruit ( $M_1$ ) or Value of the Catch ( $M_2$ ) of the San Miguel Bay Fishery, Given Prices Prevailing in 1980-81 (based on the method of Sinoda et al. 1979)**

Step 1. Estimation of set values of asymptotic size  $L_{(\infty)}$  for each species represented in the catch (in the present case, representative species for each of the statistical groupings are used). These species and their values of  $L_{(\infty)}$  are given in Table 17, p. 48.

Step 2. Estimation of a selection factor (S.F.) for each species considered. In the present case, most of the S.F. values were taken from Tables 1 and 2 in Sinoda et al. (1979); the remaining S.F. values were determined using the nomogram given in Pauly (1980, Fig. 12)

Step 3. Estimation of species-specific optimum mesh sizes ( $M_s$ ) using the relationship

$$M_s = \frac{0.59 \cdot L_{(\infty)}}{S.F.}$$

where the factor 0.59 is the midpoint of the range of  $L_c/L_{\infty}$  values known to maximize yield per recruit at high fishing mortalities (Jones 1976; Sinoda et al. 1979) and where  $L_c$  is the mean size at first capture.

Step 4. Estimation of the mesh size which maximizes total multispecies catch ( $M_1$ ), obtained by taking the mean of the  $M_s$  values, weighted by catch in weight, i.e., by performing  $\Sigma_3/\Sigma_1$  (see Table 17). The value of  $M_1$  so estimated is

$$36,976/6,808 = 5.4 \text{ cm}$$

Step 5. Estimation of the mesh size which maximizes the value of the total multispecies catch ( $M_2$ ), obtained by taking the mean of the  $M_s$  values, weighted by the value of the catch, i.e., by performing  $\Sigma_4/\Sigma_2$  (see Table 17). The value of  $M_2$  so estimated is

$$122,389/22,946 = 5.3 \text{ cm}$$





#### INSTITUTE OF FISHERIES DEVELOPMENT AND RESEARCH

The Institute of Fisheries Development and Research (IFDR) of the College of Fisheries, University of the Philippines in the Visayas was created in 1965 by Republic Act No. 4514 to undertake basic and applied researches in the major fields in fisheries, namely: marine, inland and fish processing technology, with the aim of promoting the fisheries in the country.

The Institute is also authorized to maintain experiment and demonstration stations in strategic locations in the Philippines (Rizal, Bataan, Sorsogon, Cagayan, Pangasinan, Polillo Island, Panay Island, Palawan, Sulu, Leyte and Davao).

The IFDR core staff consists of research personnel with local and foreign training and background in areas of marine biology, gear technology, aquaculture, inland fisheries and socio-economics, post-harvest technology and quality control of fish and feeds. Affiliate researchers from various agencies, both local and abroad, help strengthen the manpower capability of the Institute.

Its research facilities in the U.P. Diliman campus include marine biology and fish nutrition laboratories, fish processing and quality control laboratory and experimental hatcheries.



#### INTERNATIONAL CENTER FOR LIVING AQUATIC RESOURCES MANAGEMENT

The International Center for Living Aquatic Resources Management (ICLARM) is an autonomous, nonprofit, international scientific and technical center which has been organized to conduct, stimulate, and accelerate research on all aspects of fisheries and other living aquatic resources.

The Center was incorporated in Manila in 20 January 1977 and its operational base was established in Manila in March 1977. Although the interests of ICLARM are worldwide, initially the organization's primary attention is being directed to problems in Southeast Asia and the Southwest Pacific.

ICLARM is an operational organization, not a granting or funding entity. Its program of work is aimed to resolve critical technical and socioeconomic constraints to increased production, improved resource management, and equitable distribution of benefits in economically developing countries. It pursues these objectives in the fields of aquaculture, traditional fisheries, resource development and management, fisheries affairs, and education and training through cooperative research with institutions in developing and developed countries.

Policies are set by a Board of Trustees with members drawn from the international community. Direction of ICLARM, under the policies set by the Board, is the responsibility of the Director General. Advice on programs is received by the Director General from a Program Advisory Committee composed of scientists drawn from the international community.

The ICLARM core staff consists of internationally recruited scientists drawn from the areas of aquaculture, fishery biology, population dynamics, economics, anthropology, and international law. In addition, provision is made for interns, consultants and visiting fellows, contributing to breadth of competence and flexibility. The core program and core staff are supported by private foundations and governments.